



ALLARD ENGINEERING

civil engineering land surveying land planning

**W. Highland Ave. & Medical Center Dr
Residential
APN: 0348-141-15**

Preliminary Drainage Report

October 5, 2021

Prepared For:

**Warminton Residential
3090 Pullman Street
Costa Mesa, CA 92626
Tel: (714) 557-5511**

Prepared By:

**Allard Engineering
16866 Seville Ave
Fontana, CA 92335
Tel: (909) 356-1815
Email: rallard@allardeng.com**

Prepared under the supervision of:

Raymond J Allard, P.E. RCE 36052 Exp. 06-30-22

Discussion

Introduction

The tract at W. Highland Avenue & Medical Center Drive (APN 0143-191-59) comprises the site area of approximately 9.9 acre of the proposed 95-lot residential tract to the existing vacant undeveloped area located in the City of San Bernardino, County of San Bernardino, State of California. The site lies south of W. Highland Avenue and east of Medical Center Drive. In existing condition the site drains to the south to the side street (Madison Street). In proposed developed condition the site drains via sheet flow, swales, onsite storm drains and "V" gutter into multiple of proposed Contech chamber system (7-total). The site outlets on surface both in the existing and proposed condition at the south west corner of the south in Madison Street and the water then follow the existing drainage pattern to convey to Medical Center Drive and finally drains to the existing storm drain system (Muscott Storm Drain System, 60" RCP). The storm water ultimately conveyed to the Lytle Creek Wash via existing storm drain system.

Purpose

The purpose of this Drainage Report is to assess the existing and proposed quantities and flows that affect the site and provide necessary flood protection.

Criteria

The criteria utilized for hydrologic analysis is the San Bernardino County Hydrology Manual. Unit Hydrograph method was used to quantify the volume and Rational Method Hydrology was used to quantify the flows by utilizing the AES software.

Findings

The site consists of a single drainage area of 9.9 acres, DA-1. During a storm event (upto 100-yr storm) the most of the site drains in a southerly direction and drains into seven proposed Contech chamber systems via concrete swale/pipes/sheet flow at a slope of 1.0% and conveyed to the proposed Contech chamber system for low flow water volume (WQ) as well as 100-yr 24-hr storm event water volume for retention/infiltration. For larger flow event and/or the system failure, the water will overflow the system, drains on surface and discharge on to the street (Madison Street), follow the existing drainage pattern and finally conveys to the Medical Center Drive to discharge into the existing storm drain system (60" RCP, Muscott Storm Drain System). The proposed Contech Chamber System were sized to retain & infiltrate the stormwater into subsoil (in 48 hr drawdown period) which is the difference between the generated water volume in developed and existing condition of the site for the 100-year 24-hour storm event (Volume calculated using the Unit Hydrograph method). The flow quantity (volume) calculation was based on the site imperviousness of 0% for existing condition (barren condition) & 70% for developed condition and for the 100-year 24-hour storm event. The proposed Contech Chamber Systems (7-total) will retain and infiltrate the quantity of water in excess of existing condition for storm event up to 100-year 24-hour. The estimated water volume required to retain is 48,793 cu-ft. (Difference of water volume between developed and existing condition using unit hydrograph method). The proposed 7 (Seven) Contech Chamber System has a combined capacity to

retain/infiltrate up to 50,218 cu-ft of water. Therefore, the quantity of water drain out from the proposed developed site will remain the same or under as existing condition. We also calculated the peak flow rate from the site in existing and developed condition for 100-yr storm event. Flow generation in existing and developed condition was calculation as 21.0 CFS & 34.3 CFS. There will be an increase of 13.3 CFS in peak flow which is about 63% of the pre-developed peak flow rate. By building the 7(Seven) Contech chamber systems at the site which will attenuate the peak flow and to retain/infiltrate will decrease the discharge rate of water in developed condition to its existing condition.

Therefore, the hydrologic condition of concern (HCOC) will be eliminated at this site.

The flow from 100-yr storm will drain into the proposed 7 (seven) Contech chamber systems utilizing the proposed onsite storm drain system for retention/infiltration. When the Contech Chamber System fails and in the emergency situation, water will drain out on surface to the side street (Madison Street) , conveys to 20th Street and finally Medical Center Drive following the existing drainage pattern and discharge into the existing storm drain system (Muscott SD system, 60" RCP).

We have calculated the street capacity for Madison Street (upto right of way, 50' wide) and 20th street (upto right of way, 60' wide) to carry the flow generated from the proposed site as well as water from the offsite area. Water will be contained within the right of way of the Madison Street and 20th Street. There will be no flooding onsite or the offsite drainage area. Please refer to the existing condition Offsite Drainage Exhibit.

Calculations and exhibits are attached to support these findings.

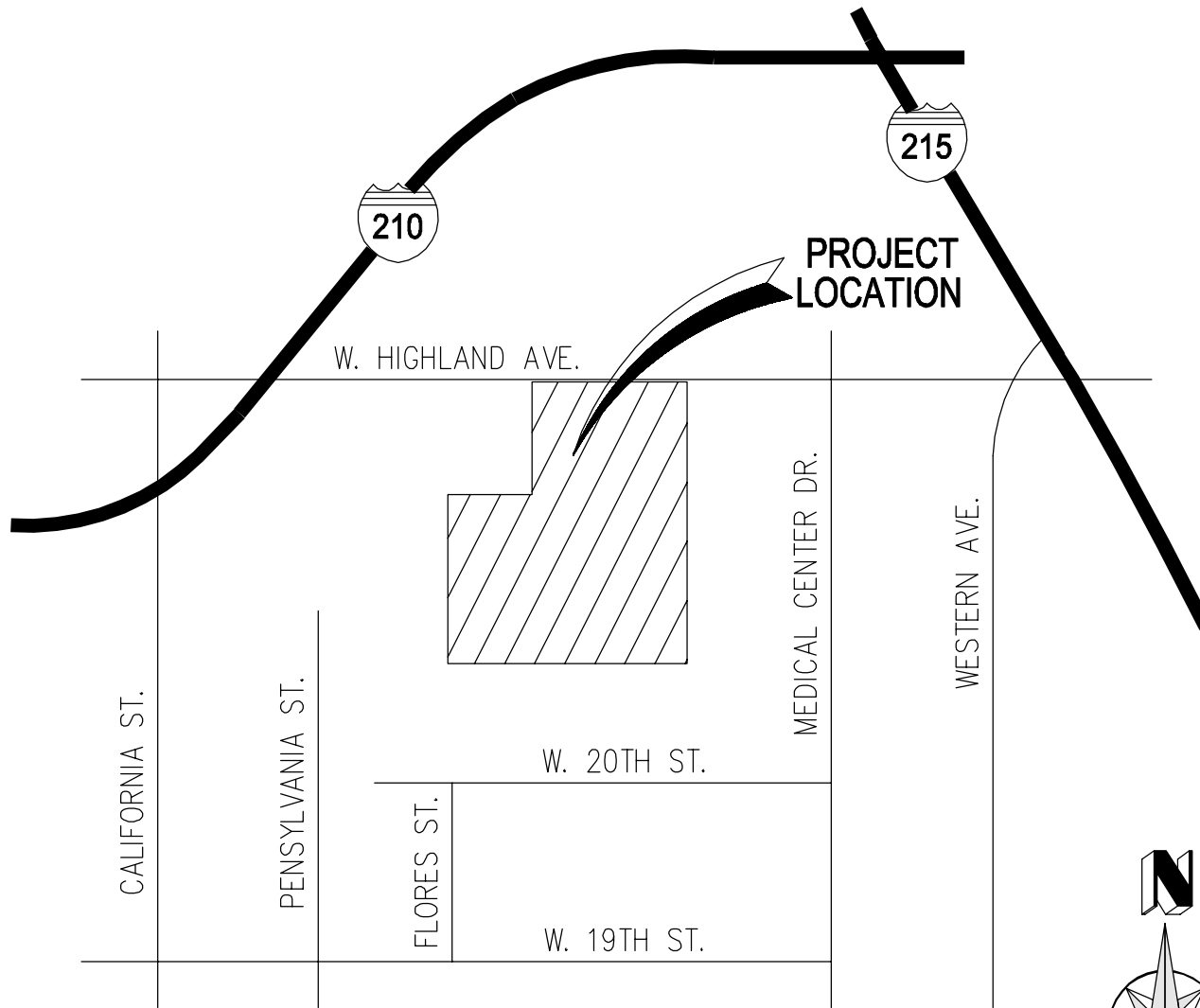

VICINITY MAP

NOT TO SCALE



NOAA Atlas 14, Volume 6, Version 2
Location name: San Bernardino, California, USA*
Latitude: 34.1349°, Longitude: -117.3254°
Elevation: 1232.88 ft**



* source: ESRI Maps
 ** source: USGS

POINT PRECIPITATION FREQUENCY ESTIMATES

Sanja Perica, Sarah Dietz, Sarah Heim, Lillian Hiner, Kazungu Maitaria, Deborah Martin, Sandra Pavlovic, Ishani Roy, Carl Trypaluk, Dale Unruh, Fenglin Yan, Michael Yekta, Tan Zhao, Geoffrey Bonnin, Daniel Brewer, Li-Chuan Chen, Tye Parzybok, John Yarchoan

NOAA, National Weather Service, Silver Spring, Maryland

[PF_tabular](#) | [PF_graphical](#) | [Maps & aerials](#)

PF tabular

PDS-based point precipitation frequency estimates with 90% confidence intervals (in inches)¹										
Duration	Average recurrence interval (years)									
	1	2	5	10	25	50	100	200	500	1000
5-min	0.125 (0.104-0.152)	0.163 (0.136-0.199)	0.216 (0.179-0.263)	0.260 (0.213-0.319)	0.321 (0.255-0.409)	0.371 (0.288-0.482)	0.422 (0.320-0.563)	0.478 (0.352-0.656)	0.556 (0.393-0.797)	0.620 (0.423-0.920)
10-min	0.179 (0.149-0.217)	0.234 (0.195-0.285)	0.309 (0.256-0.377)	0.372 (0.306-0.457)	0.461 (0.366-0.586)	0.531 (0.413-0.691)	0.606 (0.459-0.807)	0.685 (0.504-0.940)	0.798 (0.563-1.14)	0.889 (0.606-1.32)
15-min	0.216 (0.180-0.263)	0.283 (0.235-0.344)	0.374 (0.310-0.456)	0.450 (0.370-0.553)	0.557 (0.442-0.709)	0.642 (0.499-0.835)	0.732 (0.555-0.976)	0.828 (0.610-1.14)	0.965 (0.681-1.38)	1.08 (0.732-1.60)
30-min	0.321 (0.267-0.390)	0.420 (0.349-0.511)	0.554 (0.459-0.676)	0.667 (0.548-0.820)	0.826 (0.656-1.05)	0.953 (0.740-1.24)	1.09 (0.823-1.45)	1.23 (0.905-1.69)	1.43 (1.01-2.05)	1.60 (1.09-2.37)
60-min	0.469 (0.390-0.569)	0.614 (0.510-0.747)	0.810 (0.671-0.988)	0.975 (0.801-1.20)	1.21 (0.958-1.54)	1.39 (1.08-1.81)	1.59 (1.20-2.12)	1.80 (1.32-2.46)	2.09 (1.48-2.99)	2.33 (1.59-3.46)
2-hr	0.681 (0.566-0.827)	0.875 (0.727-1.06)	1.14 (0.940-1.38)	1.35 (1.11-1.66)	1.65 (1.31-2.10)	1.88 (1.46-2.45)	2.13 (1.61-2.84)	2.38 (1.76-3.27)	2.74 (1.93-3.92)	3.03 (2.06-4.49)
3-hr	0.841 (0.699-1.02)	1.07 (0.892-1.31)	1.38 (1.15-1.69)	1.64 (1.35-2.01)	1.99 (1.58-2.53)	2.26 (1.76-2.94)	2.55 (1.93-3.39)	2.84 (2.09-3.90)	3.25 (2.29-4.65)	3.57 (2.43-5.30)
6-hr	1.19 (0.991-1.45)	1.51 (1.26-1.84)	1.94 (1.61-2.36)	2.29 (1.88-2.81)	2.76 (2.19-3.51)	3.13 (2.43-4.06)	3.50 (2.65-4.66)	3.89 (2.86-5.33)	4.41 (3.12-6.32)	4.83 (3.29-7.16)
12-hr	1.58 (1.32-1.92)	2.02 (1.68-2.46)	2.60 (2.15-3.17)	3.06 (2.52-3.77)	3.69 (2.93-4.70)	4.17 (3.24-5.42)	4.66 (3.53-6.21)	5.16 (3.80-7.08)	5.84 (4.12-8.35)	6.36 (4.33-9.43)
24-hr	2.11 (1.87-2.44)	2.74 (2.42-3.16)	3.54 (3.12-4.10)	4.19 (3.67-4.89)	5.07 (4.29-6.10)	5.73 (4.76-7.05)	6.40 (5.19-8.07)	7.09 (5.59-9.18)	8.01 (6.06-10.8)	8.72 (6.38-12.2)
2-day	2.58 (2.28-2.97)	3.39 (3.00-3.92)	4.46 (3.93-5.16)	5.33 (4.66-6.21)	6.50 (5.50-7.83)	7.40 (6.14-9.10)	8.31 (6.73-10.5)	9.25 (7.29-12.0)	10.5 (7.96-14.2)	11.5 (8.42-16.1)
3-day	2.75 (2.44-3.17)	3.68 (3.25-4.24)	4.90 (4.33-5.67)	5.91 (5.17-6.89)	7.29 (6.17-8.78)	8.36 (6.94-10.3)	9.46 (7.66-11.9)	10.6 (8.35-13.7)	12.2 (9.20-16.4)	13.4 (9.79-18.7)
4-day	2.93 (2.59-3.37)	3.95 (3.50-4.56)	5.31 (4.69-6.15)	6.44 (5.64-7.51)	8.00 (6.77-9.64)	9.22 (7.65-11.3)	10.5 (8.48-13.2)	11.8 (9.29-15.3)	13.6 (10.3-18.3)	15.0 (11.0-21.0)

7-day	3.31 (2.93-3.81)	4.51 (3.99-5.21)	6.12 (5.40-7.08)	7.46 (6.53-8.70)	9.32 (7.90-11.2)	10.8 (8.95-13.3)	12.3 (9.97-15.5)	13.9 (11.0-18.0)	16.1 (12.2-21.7)	17.9 (13.1-25.0)
10-day	3.61 (3.19-4.16)	4.95 (4.38-5.71)	6.76 (5.96-7.81)	8.26 (7.23-9.63)	10.4 (8.78-12.5)	12.0 (9.98-14.8)	13.8 (11.1-17.3)	15.6 (12.3-20.2)	18.1 (13.7-24.4)	20.2 (14.7-28.1)
20-day	4.44 (3.93-5.12)	6.16 (5.45-7.11)	8.48 (7.48-9.81)	10.4 (9.13-12.2)	13.2 (11.2-15.9)	15.4 (12.7-18.9)	17.6 (14.3-22.2)	20.1 (15.8-26.0)	23.5 (17.7-31.6)	26.2 (19.2-36.5)
30-day	5.24 (4.64-6.04)	7.29 (6.44-8.40)	10.1 (8.87-11.6)	12.4 (10.8-14.4)	15.7 (13.3-18.9)	18.3 (15.2-22.5)	21.0 (17.0-26.5)	24.0 (18.9-31.0)	28.1 (21.2-37.9)	31.4 (23.0-43.8)
45-day	6.28 (5.56-7.24)	8.70 (7.70-10.0)	12.0 (10.6-13.9)	14.7 (12.9-17.2)	18.6 (15.8-22.5)	21.7 (18.0-26.7)	25.0 (20.3-31.5)	28.5 (22.5-36.9)	33.4 (25.3-45.1)	37.4 (27.4-52.2)
60-day	7.34 (6.50-8.45)	10.1 (8.92-11.6)	13.8 (12.2-16.0)	16.9 (14.8-19.8)	21.4 (18.1-25.7)	24.9 (20.7-30.6)	28.6 (23.2-36.0)	32.6 (25.7-42.2)	38.2 (28.9-51.5)	42.7 (31.2-59.6)

¹ Precipitation frequency (PF) estimates in this table are based on frequency analysis of partial duration series (PDS). Numbers in parenthesis are PF estimates at lower and upper bounds of the 90% confidence interval. The probability that precipitation frequency estimates (for a given duration and average recurrence interval) will be greater than the upper bound (or less than the lower bound) is 5%. Estimates at upper bounds are not checked against probable maximum precipitation (PMP) estimates and may be higher than currently valid PMP values. Please refer to NOAA Atlas 14 document for more information.

[Back to Top](#)

PF graphical

PDS-based depth-duration-frequency (DDF) curves
Latitude: 34.1349°, Longitude: -117.3254°

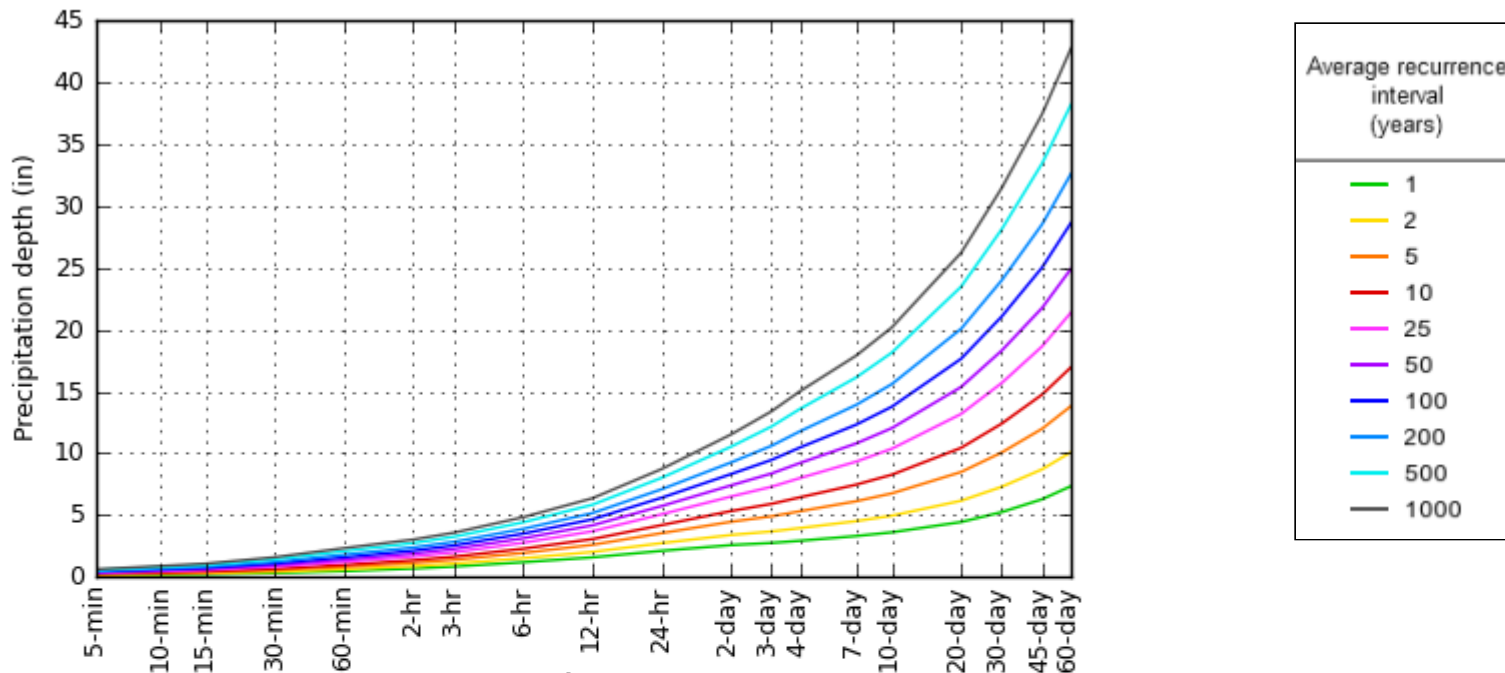

ACTUAL IMPERVIOUS COVER

Land Use (1)	Range-Percent	Recommended Value For Average Conditions-Percent (2)
Natural or Agriculture	0 - 0	0
Public Park	10 - 25	15
School	30 - 50	40
Single Family Residential: (3)		
2.5 acre lots	5 - 15	10
1 acre lots	10 - 25	20
2 dwellings/acre	20 - 40	30
3-4 dwellings/acre	30 - 50	40
5-7 dwellings/acre	35 - 55	50
8-10 dwellings/acre	50 - 70	60
More than 10 dwellings/acre	65 - 90	80
Multiple Family Residential:		
Condominiums	45 - 70	65
Apartments	65 - 90	80
Mobile Home Park	60 - 85	75
Commercial, Downtown Business or Industrial	80 - 100	90

Notes:

1. Land use should be based on ultimate development of the watershed. Long range master plans for the County and incorporated cities should be reviewed to insure reasonable land use assumptions.
2. Recommended values are based on average conditions which may not apply to a particular study area. The percentage impervious may vary greatly even on comparable sized lots due to differences in dwelling size, improvements, etc. Landscape practices should also be considered as it is common in some areas to use ornamental gravels underlain by impervious plastic materials in place of lawns and shrubs. A field investigation of a study area shall always be made, and a review of aerial photos, where available, may assist in estimating the percentage of impervious cover in developed areas.
3. For typical equestrian subdivisions increase impervious area 5 percent over the values recommended in the table above.

SAN BERNARDINO COUNTY
HYDROLOGY MANUAL

ACTUAL IMPERVIOUS COVER
FOR
DEVELOPED AREAS

RATIONAL METHOD HYDROLOGY METHOD

PEAK FLOW CALCULATION
(100-YR STORM EVENT)

**RATIONAL METHOD HYDROLOGY-2YR STORM EVENT
DEVELOPED CONDITION**

RATIONAL METHOD HYDROLOGY COMPUTER PROGRAM PACKAGE
(Reference: 1986 SAN BERNARDINO CO. HYDROLOGY CRITERION)
(c) Copyright 1983-2016 Advanced Engineering Software (aes)
Ver. 23.0 Release Date: 07/01/2016 License ID 1400

Analysis prepared by:

***** DESCRIPTION OF STUDY *****
* MEDICAL CENTER DR SITE *
* 100-YR STORM EVENT *
* DEVELOPED CONDITION *

FILE NAME: PALM.DAT
TIME/DATE OF STUDY: 13:11 10/05/2021

=====

USER SPECIFIED HYDROLOGY AND HYDRAULIC MODEL INFORMATION:

=====

--*TIME-OF-CONCENTRATION MODEL*--

USER SPECIFIED STORM EVENT(YEAR) = 100.00
SPECIFIED MINIMUM PIPE SIZE(INCH) = 12.00
SPECIFIED PERCENT OF GRADIENTS(DECIMAL) TO USE FOR FRICTION SLOPE = 0.90
USER-DEFINED LOGARITHMIC INTERPOLATION USED FOR RAINFALL

SLOPE OF INTENSITY DURATION CURVE(LOG(I;IN/HR) vs. LOG(Tc;MIN)) = 0.7000
USER SPECIFIED 1-HOUR INTENSITY(INCH/HOUR) = 1.5900

ANTECEDENT MOISTURE CONDITION (AMC) III ASSUMED FOR RATIONAL METHOD

USER-DEFINED STREET-SECTIONS FOR COUPLED PIPEFLOW AND STREETFLOW MODEL

NO.	WIDTH (FT)	CROSSFALL (FT)	STREET-CROSSFALL: IN- / OUT-/PARK- SIDE / SIDE/ WAY	CURB HEIGHT (FT)	GUTTER WIDTH (FT)	GEOMETRIES: LIP (FT)	MANNING HIKE (FT)	FACTOR (n)
1	30.0	20.0	0.018/0.018/0.020	0.67	2.00	0.0313	0.167	0.0150

GLOBAL STREET FLOW-DEPTH CONSTRAINTS:
1. Relative Flow-Depth = 0.00 FEET
as (Maximum Allowable Street Flow Depth) - (Top-of-Curb)
2. (Depth)*(Velocity) Constraint = 6.0 (FT*FT/S)
*SIZE PIPE WITH A FLOW CAPACITY GREATER THAN
OR EQUAL TO THE UPSTREAM TRIBUTARY PIPE.*
*USER-SPECIFIED MINIMUM TOPOGRAPHIC SLOPE ADJUSTMENT NOT SELECTED

FLOW PROCESS FROM NODE 100.00 TO NODE 101.00 IS CODE = 21

>>>>RATIONAL METHOD INITIAL SUBAREA ANALYSIS<<<<<
>>USE TIME-OF-CONCENTRATION NOMOGRAPH FOR INITIAL SUBAREA<<
=====

INITIAL SUBAREA FLOW-LENGTH(FEET) = 1115.00
ELEVATION DATA: UPSTREAM(FEET) = 1240.30 DOWNSTREAM(FEET) = 1228.16

Tc = K*[(LENGTH** 3.00)/(ELEVATION CHANGE)]**0.20
SUBAREA ANALYSIS USED MINIMUM Tc(MIN.) = 15.289
* 100 YEAR RAINFALL INTENSITY(INCH/HR) = 4.140
SUBAREA Tc AND LOSS RATE DATA(AMC III):

DEVELOPMENT TYPE/ LAND USE	SCS SOIL GROUP	AREA (ACRES)	Fp (INCH/HR)	Ap (DECIMAL)	SCS CN	Tc (MIN.)
RESIDENTIAL "8-10 DWELLINGS/ACRE"	A	9.90	0.74	0.400	52	15.29

SUBAREA AVERAGE PERVIOUS LOSS RATE, Fp(INCH/HR) = 0.74
SUBAREA AVERAGE PERVIOUS AREA FRACTION, Ap = 0.400

SUBAREA RUNOFF(CFS) = 34.25
TOTAL AREA(ACRES) = 9.90 PEAK FLOW RATE(CFS) = 34.25

=====

END OF STUDY SUMMARY:

TOTAL AREA(ACRES) = 9.9 TC(MIN.) = 15.29 ←
EFFECTIVE AREA(ACRES) = 9.90 AREA-AVERAGED Fm(INCH/HR)= 0.30
AREA-AVERAGED Fp(INCH/HR) = 0.74 AREA-AVERAGED Ap = 0.400
PEAK FLOW RATE(CFS) = 34.25 ←

=====

END OF RATIONAL METHOD ANALYSIS

**RATIONAL METHOD HYDROLOGY-2YR STORM EVENT
EXISTING CONDITION**

RATIONAL METHOD HYDROLOGY COMPUTER PROGRAM PACKAGE
(Reference: 1986 SAN BERNARDINO CO. HYDROLOGY CRITERION)
(c) Copyright 1983-2016 Advanced Engineering Software (aes)
Ver. 23.0 Release Date: 07/01/2016 License ID 1400

Analysis prepared by:

***** DESCRIPTION OF STUDY *****
* MEDICAL CENTER DR SITE *
* 100-yr existing *
* EXISTING CONDITION *

FILE NAME: PALM.DAT
TIME/DATE OF STUDY: 13:33 10/05/2021

=====

USER SPECIFIED HYDROLOGY AND HYDRAULIC MODEL INFORMATION:

=====

--*TIME-OF-CONCENTRATION MODEL*--

USER SPECIFIED STORM EVENT(YEAR) = 100.00
SPECIFIED MINIMUM PIPE SIZE(INCH) = 12.00
SPECIFIED PERCENT OF GRADIENTS(DECIMAL) TO USE FOR FRICTION SLOPE = 0.90
USER-DEFINED LOGARITHMIC INTERPOLATION USED FOR RAINFALL

SLOPE OF INTENSITY DURATION CURVE(LOG(I;IN/HR) vs. LOG(Tc;MIN)) = 0.7000
USER SPECIFIED 1-HOUR INTENSITY(INCH/HOUR) = 1.5900

ANTECEDENT MOISTURE CONDITION (AMC) III ASSUMED FOR RATIONAL METHOD

USER-DEFINED STREET-SECTIONS FOR COUPLED PIPEFLOW AND STREETFLOW MODEL

NO.	WIDTH (FT)	CROSSFALL (FT)	STREET-CROSSFALL: IN- / OUT-/PARK- SIDE / SIDE/ WAY	CURB HEIGHT (FT)	GUTTER WIDTH (FT)	LIP (FT)	HIKE (FT)	FACTOR (n)
1	30.0	20.0	0.018/0.018/0.020	0.67	2.00	0.0312	0.167	0.0150

GLOBAL STREET FLOW-DEPTH CONSTRAINTS:
1. Relative Flow-Depth = 0.00 FEET
as (Maximum Allowable Street Flow Depth) - (Top-of-Curb)
2. (Depth)*(Velocity) Constraint = 6.0 (FT*FT/S)
*SIZE PIPE WITH A FLOW CAPACITY GREATER THAN
OR EQUAL TO THE UPSTREAM TRIBUTARY PIPE.*
*USER-SPECIFIED MINIMUM TOPOGRAPHIC SLOPE ADJUSTMENT NOT SELECTED

FLOW PROCESS FROM NODE 100.00 TO NODE 101.00 IS CODE = 21

>>>>RATIONAL METHOD INITIAL SUBAREA ANALYSIS<<<<<
>>USE TIME-OF-CONCENTRATION NOMOGRAPH FOR INITIAL SUBAREA<<
=====

INITIAL SUBAREA FLOW-LENGTH(FEET) = 905.00
ELEVATION DATA: UPSTREAM(FEET) = 1240.30 DOWNSTREAM(FEET) = 1228.00

Tc = K*[(LENGTH** 3.00)/(ELEVATION CHANGE)]**0.20
SUBAREA ANALYSIS USED MINIMUM Tc(MIN.) = 25.399
* 100 YEAR RAINFALL INTENSITY(INCH/HR) = 2.902
SUBAREA Tc AND LOSS RATE DATA(AMC III):

DEVELOPMENT TYPE/ LAND USE	SCS SOIL GROUP	AREA (ACRES)	Fp (INCH/HR)	Ap (DECIMAL)	SCS CN	Tc (MIN.)
NATURAL FAIR COVER "OPEN BRUSH"	A	9.90	0.55	1.000	66	25.40

SUBAREA AVERAGE PERVIOUS LOSS RATE, Fp(INCH/HR) = 0.55
SUBAREA AVERAGE PERVIOUS AREA FRACTION, Ap = 1.000

SUBAREA RUNOFF(CFS) = 20.99
TOTAL AREA(ACRES) = 9.90 PEAK FLOW RATE(CFS) = 20.99

=====

END OF STUDY SUMMARY:

TOTAL AREA(ACRES) = 9.9 TC(MIN.) = 25.40
EFFECTIVE AREA(ACRES) = 9.90 AREA-AVERAGED Fm(INCH/HR)= 0.55
AREA-AVERAGED Fp(INCH/HR) = 0.55 AREA-AVERAGED Ap = 1.000
PEAK FLOW RATE(CFS) = 20.99

=====

END OF RATIONAL METHOD ANALYSIS

RETENTION WATER VOLUME CALCULATION
100-YR, 24 HR STORM EVENT
(Unit Hydrograph Method)

**UNIT HYDROGRAPH METHOD-100YR, 24HR STORM EVENT
DEVELOPED CONDITION**

Unit Hydrograph Analysis

Copyright (c) CIVILCADD/CIVILDESIGN, 1989 - 2018, Version 9.0

Study date 10/05/21

+++++

San Bernardino County Synthetic Unit Hydrology Method
Manual date - August 1986

Program License Serial Number 6484

UH METHOD
100-YR 24-HR STROM EVENT
DEVELOPED CONDITION

Storm Event Year = 100

Antecedent Moisture Condition = 3

English (in-lb) Input Units Used

English Rainfall Data (Inches) Input Values Used

English Units used in output format

Area averaged rainfall intensity isohyetal data:
Sub-Area Duration Isohyetal
(Ac.) (hours) (In)
Rainfall data for year 100
9.90 1 1.59

Rainfall data for year 100
9.90 6 3.50

Rainfall data for year 100
9.90 24 6.40

+++++

***** Area-averaged max loss rate, Fm *****

SCS curve No.(AMCII)	SCS curve NO.(AMC 3)	Area (Ac.)	Area Fraction	Fp(Fig C6) (In/Hr)	Ap (dec.)	Fm (In/Hr)
32.0	52.0	9.90	1.000	0.785	0.400	0.314

Area-averaged adjusted loss rate Fm (In/Hr) = 0.314

***** Area-Averaged low loss rate fraction, Yb *****

Area (Ac.)	Area Fract	SCS CN (AMC2)	SCS CN (AMC3)	S	Pervious Yield Fr
3.96	0.400	32.0	52.0	9.23	0.235
5.94	0.600	98.0	98.0	0.20	0.963

Area-averaged catchment yield fraction, Y = 0.672

Area-averaged low loss fraction, Yb = 0.328

Direct entry of lag time by user

+++++

Watershed area = 9.90(Ac.)
 Catchment Lag time = 0.204 hours
 Unit interval = 5.000 minutes
 Unit interval percentage of lag time = 40.8497
 Hydrograph baseflow = 0.00(CFS)
 Average maximum watershed loss rate(Fm) = 0.314(In/Hr)
 Average low loss rate fraction (Yb) = 0.328 (decimal)
 VALLEY DEVELOPED S-Graph Selected
 Computed peak 5-minute rainfall = 0.754(In)
 Computed peak 30-minute rainfall = 1.291(In)
 Specified peak 1-hour rainfall = 1.590(In)
 Computed peak 3-hour rainfall = 2.579(In)
 Specified peak 6-hour rainfall = 3.500(In)
 Specified peak 24-hour rainfall = 6.400(In)

Rainfall depth area reduction factors:

Using a total area of 9.90(Ac.) (Ref: fig. E-4)

5-minute factor = 1.000	Adjusted rainfall = 0.754(In)
30-minute factor = 1.000	Adjusted rainfall = 1.291(In)
1-hour factor = 1.000	Adjusted rainfall = 1.589(In)
3-hour factor = 1.000	Adjusted rainfall = 2.579(In)
6-hour factor = 1.000	Adjusted rainfall = 3.500(In)
24-hour factor = 1.000	Adjusted rainfall = 6.400(In)

U n i t H y d r o g r a p h

Interval Number	'S' Graph Mean values	Unit Hydrograph ((CFS))
(K = 119.73 (CFS))		
1	3.149	3.771
2	20.376	20.625
3	51.474	37.233
4	79.346	33.370
5	91.904	15.035
6	97.070	6.186
7	98.579	1.807
8	99.315	0.880
9	100.000	0.821

Peak Unit Number	Adjusted mass rainfall (In)	Unit rainfall (In)
1	0.7541	0.7541
2	0.9284	0.1743
3	1.0485	0.1201
4	1.1430	0.0945
5	1.2222	0.0791
6	1.2909	0.0687
7	1.3520	0.0611
8	1.4072	0.0553
9	1.4579	0.0506
10	1.5047	0.0468
11	1.5483	0.0436
12	1.5893	0.0409
13	1.6463	0.0571
14	1.7010	0.0547
15	1.7535	0.0525
16	1.8041	0.0506
17	1.8530	0.0489
18	1.9002	0.0473
19	1.9460	0.0458
20	1.9905	0.0445
21	2.0338	0.0433
22	2.0759	0.0421
23	2.1170	0.0411
24	2.1571	0.0401
25	2.1963	0.0392

26	2.2346	0.0383
27	2.2720	0.0375
28	2.3087	0.0367
29	2.3447	0.0360
30	2.3800	0.0353
31	2.4147	0.0346
32	2.4487	0.0340
33	2.4821	0.0334
34	2.5150	0.0329
35	2.5473	0.0323
36	2.5792	0.0318
37	2.6105	0.0313
38	2.6413	0.0308
39	2.6717	0.0304
40	2.7017	0.0300
41	2.7312	0.0295
42	2.7603	0.0291
43	2.7891	0.0288
44	2.8175	0.0284
45	2.8455	0.0280
46	2.8732	0.0277
47	2.9005	0.0273
48	2.9275	0.0270
49	2.9542	0.0267
50	2.9806	0.0264
51	3.0068	0.0261
52	3.0326	0.0258
53	3.0581	0.0255
54	3.0834	0.0253
55	3.1084	0.0250
56	3.1332	0.0248
57	3.1577	0.0245
58	3.1820	0.0243
59	3.2060	0.0240
60	3.2299	0.0238
61	3.2535	0.0236
62	3.2768	0.0234
63	3.3000	0.0232
64	3.3230	0.0230
65	3.3457	0.0228
66	3.3683	0.0226
67	3.3907	0.0224
68	3.4129	0.0222
69	3.4349	0.0220
70	3.4567	0.0218
71	3.4784	0.0217
72	3.4999	0.0215
73	3.5210	0.0211
74	3.5419	0.0209
75	3.5627	0.0208
76	3.5833	0.0206
77	3.6037	0.0205
78	3.6240	0.0203
79	3.6442	0.0202
80	3.6642	0.0200
81	3.6840	0.0199
82	3.7038	0.0197
83	3.7234	0.0196
84	3.7428	0.0195
85	3.7622	0.0193
86	3.7814	0.0192
87	3.8005	0.0191
88	3.8194	0.0190
89	3.8383	0.0188
90	3.8570	0.0187
91	3.8756	0.0186
92	3.8941	0.0185
93	3.9124	0.0184
94	3.9307	0.0183
95	3.9488	0.0182
96	3.9669	0.0180

97	3.9848	0.0179
98	4.0027	0.0178
99	4.0204	0.0177
100	4.0380	0.0176
101	4.0555	0.0175
102	4.0730	0.0174
103	4.0903	0.0173
104	4.1076	0.0172
105	4.1247	0.0171
106	4.1418	0.0171
107	4.1587	0.0170
108	4.1756	0.0169
109	4.1924	0.0168
110	4.2091	0.0167
111	4.2257	0.0166
112	4.2422	0.0165
113	4.2587	0.0164
114	4.2751	0.0164
115	4.2914	0.0163
116	4.3076	0.0162
117	4.3237	0.0161
118	4.3397	0.0161
119	4.3557	0.0160
120	4.3716	0.0159
121	4.3874	0.0158
122	4.4032	0.0157
123	4.4189	0.0157
124	4.4345	0.0156
125	4.4500	0.0155
126	4.4655	0.0155
127	4.4809	0.0154
128	4.4962	0.0153
129	4.5114	0.0153
130	4.5266	0.0152
131	4.5418	0.0151
132	4.5568	0.0151
133	4.5718	0.0150
134	4.5868	0.0149
135	4.6016	0.0149
136	4.6164	0.0148
137	4.6312	0.0147
138	4.6459	0.0147
139	4.6605	0.0146
140	4.6751	0.0146
141	4.6896	0.0145
142	4.7040	0.0145
143	4.7184	0.0144
144	4.7328	0.0143
145	4.7470	0.0143
146	4.7613	0.0142
147	4.7754	0.0142
148	4.7896	0.0141
149	4.8036	0.0141
150	4.8176	0.0140
151	4.8316	0.0140
152	4.8455	0.0139
153	4.8593	0.0139
154	4.8731	0.0138
155	4.8869	0.0138
156	4.9006	0.0137
157	4.9142	0.0137
158	4.9279	0.0136
159	4.9414	0.0136
160	4.9549	0.0135
161	4.9684	0.0135
162	4.9818	0.0134
163	4.9952	0.0134
164	5.0085	0.0133
165	5.0217	0.0133
166	5.0350	0.0132
167	5.0482	0.0132

168	5.0613	0.0131
169	5.0744	0.0131
170	5.0874	0.0131
171	5.1004	0.0130
172	5.1134	0.0130
173	5.1263	0.0129
174	5.1392	0.0129
175	5.1520	0.0128
176	5.1648	0.0128
177	5.1776	0.0128
178	5.1903	0.0127
179	5.2030	0.0127
180	5.2156	0.0126
181	5.2282	0.0126
182	5.2408	0.0126
183	5.2533	0.0125
184	5.2658	0.0125
185	5.2782	0.0124
186	5.2906	0.0124
187	5.3030	0.0124
188	5.3153	0.0123
189	5.3276	0.0123
190	5.3399	0.0123
191	5.3521	0.0122
192	5.3643	0.0122
193	5.3764	0.0121
194	5.3885	0.0121
195	5.4006	0.0121
196	5.4126	0.0120
197	5.4246	0.0120
198	5.4366	0.0120
199	5.4485	0.0119
200	5.4604	0.0119
201	5.4723	0.0119
202	5.4842	0.0118
203	5.4960	0.0118
204	5.5077	0.0118
205	5.5195	0.0117
206	5.5312	0.0117
207	5.5428	0.0117
208	5.5545	0.0116
209	5.5661	0.0116
210	5.5777	0.0116
211	5.5892	0.0115
212	5.6007	0.0115
213	5.6122	0.0115
214	5.6237	0.0115
215	5.6351	0.0114
216	5.6465	0.0114
217	5.6579	0.0114
218	5.6692	0.0113
219	5.6805	0.0113
220	5.6918	0.0113
221	5.7030	0.0112
222	5.7143	0.0112
223	5.7255	0.0112
224	5.7366	0.0112
225	5.7478	0.0111
226	5.7589	0.0111
227	5.7699	0.0111
228	5.7810	0.0111
229	5.7920	0.0110
230	5.8030	0.0110
231	5.8140	0.0110
232	5.8249	0.0109
233	5.8359	0.0109
234	5.8467	0.0109
235	5.8576	0.0109
236	5.8685	0.0108
237	5.8793	0.0108
238	5.8901	0.0108

239	5.9008	0.0108
240	5.9115	0.0107
241	5.9223	0.0107
242	5.9329	0.0107
243	5.9436	0.0107
244	5.9542	0.0106
245	5.9649	0.0106
246	5.9754	0.0106
247	5.9860	0.0106
248	5.9965	0.0105
249	6.0071	0.0105
250	6.0176	0.0105
251	6.0280	0.0105
252	6.0385	0.0104
253	6.0489	0.0104
254	6.0593	0.0104
255	6.0697	0.0104
256	6.0800	0.0104
257	6.0903	0.0103
258	6.1006	0.0103
259	6.1109	0.0103
260	6.1212	0.0103
261	6.1314	0.0102
262	6.1416	0.0102
263	6.1518	0.0102
264	6.1620	0.0102
265	6.1722	0.0102
266	6.1823	0.0101
267	6.1924	0.0101
268	6.2025	0.0101
269	6.2126	0.0101
270	6.2226	0.0100
271	6.2326	0.0100
272	6.2426	0.0100
273	6.2526	0.0100
274	6.2626	0.0100
275	6.2725	0.0099
276	6.2824	0.0099
277	6.2923	0.0099
278	6.3022	0.0099
279	6.3121	0.0099
280	6.3219	0.0098
281	6.3317	0.0098
282	6.3415	0.0098
283	6.3513	0.0098
284	6.3611	0.0098
285	6.3708	0.0097
286	6.3805	0.0097
287	6.3902	0.0097
288	6.3999	0.0097

Unit Period (number)	Unit Rainfall (In)	Unit Soil-Loss (In)	Effective Rainfall (In)
1	0.0097	0.0032	0.0065
2	0.0097	0.0032	0.0065
3	0.0097	0.0032	0.0065
4	0.0098	0.0032	0.0066
5	0.0098	0.0032	0.0066
6	0.0098	0.0032	0.0066
7	0.0099	0.0032	0.0066
8	0.0099	0.0032	0.0066
9	0.0099	0.0033	0.0067
10	0.0099	0.0033	0.0067
11	0.0100	0.0033	0.0067
12	0.0100	0.0033	0.0067
13	0.0100	0.0033	0.0067
14	0.0101	0.0033	0.0068
15	0.0101	0.0033	0.0068
16	0.0101	0.0033	0.0068

17	0.0102	0.0033	0.0068
18	0.0102	0.0033	0.0068
19	0.0102	0.0034	0.0069
20	0.0103	0.0034	0.0069
21	0.0103	0.0034	0.0069
22	0.0103	0.0034	0.0069
23	0.0104	0.0034	0.0070
24	0.0104	0.0034	0.0070
25	0.0104	0.0034	0.0070
26	0.0105	0.0034	0.0070
27	0.0105	0.0035	0.0071
28	0.0105	0.0035	0.0071
29	0.0106	0.0035	0.0071
30	0.0106	0.0035	0.0071
31	0.0107	0.0035	0.0072
32	0.0107	0.0035	0.0072
33	0.0107	0.0035	0.0072
34	0.0108	0.0035	0.0072
35	0.0108	0.0036	0.0073
36	0.0108	0.0036	0.0073
37	0.0109	0.0036	0.0073
38	0.0109	0.0036	0.0073
39	0.0110	0.0036	0.0074
40	0.0110	0.0036	0.0074
41	0.0111	0.0036	0.0074
42	0.0111	0.0036	0.0074
43	0.0111	0.0037	0.0075
44	0.0112	0.0037	0.0075
45	0.0112	0.0037	0.0075
46	0.0112	0.0037	0.0076
47	0.0113	0.0037	0.0076
48	0.0113	0.0037	0.0076
49	0.0114	0.0037	0.0077
50	0.0114	0.0038	0.0077
51	0.0115	0.0038	0.0077
52	0.0115	0.0038	0.0077
53	0.0116	0.0038	0.0078
54	0.0116	0.0038	0.0078
55	0.0117	0.0038	0.0078
56	0.0117	0.0038	0.0079
57	0.0118	0.0039	0.0079
58	0.0118	0.0039	0.0079
59	0.0119	0.0039	0.0080
60	0.0119	0.0039	0.0080
61	0.0120	0.0039	0.0080
62	0.0120	0.0039	0.0081
63	0.0121	0.0040	0.0081
64	0.0121	0.0040	0.0081
65	0.0122	0.0040	0.0082
66	0.0122	0.0040	0.0082
67	0.0123	0.0040	0.0083
68	0.0123	0.0040	0.0083
69	0.0124	0.0041	0.0083
70	0.0124	0.0041	0.0084
71	0.0125	0.0041	0.0084
72	0.0126	0.0041	0.0084
73	0.0126	0.0041	0.0085
74	0.0127	0.0042	0.0085
75	0.0128	0.0042	0.0086
76	0.0128	0.0042	0.0086
77	0.0129	0.0042	0.0087
78	0.0129	0.0042	0.0087
79	0.0130	0.0043	0.0087
80	0.0131	0.0043	0.0088
81	0.0131	0.0043	0.0088
82	0.0132	0.0043	0.0089
83	0.0133	0.0044	0.0089
84	0.0133	0.0044	0.0089
85	0.0134	0.0044	0.0090
86	0.0135	0.0044	0.0090
87	0.0136	0.0045	0.0091

88	0.0136	0.0045	0.0091
89	0.0137	0.0045	0.0092
90	0.0138	0.0045	0.0092
91	0.0139	0.0045	0.0093
92	0.0139	0.0046	0.0093
93	0.0140	0.0046	0.0094
94	0.0141	0.0046	0.0094
95	0.0142	0.0047	0.0095
96	0.0142	0.0047	0.0096
97	0.0143	0.0047	0.0096
98	0.0144	0.0047	0.0097
99	0.0145	0.0048	0.0097
100	0.0146	0.0048	0.0098
101	0.0147	0.0048	0.0099
102	0.0147	0.0048	0.0099
103	0.0149	0.0049	0.0100
104	0.0149	0.0049	0.0100
105	0.0151	0.0049	0.0101
106	0.0151	0.0050	0.0102
107	0.0153	0.0050	0.0102
108	0.0153	0.0050	0.0103
109	0.0155	0.0051	0.0104
110	0.0155	0.0051	0.0104
111	0.0157	0.0051	0.0105
112	0.0157	0.0052	0.0106
113	0.0159	0.0052	0.0107
114	0.0160	0.0052	0.0107
115	0.0161	0.0053	0.0108
116	0.0162	0.0053	0.0109
117	0.0164	0.0054	0.0110
118	0.0164	0.0054	0.0110
119	0.0166	0.0055	0.0112
120	0.0167	0.0055	0.0112
121	0.0169	0.0055	0.0113
122	0.0170	0.0056	0.0114
123	0.0171	0.0056	0.0115
124	0.0172	0.0057	0.0116
125	0.0174	0.0057	0.0117
126	0.0175	0.0058	0.0118
127	0.0177	0.0058	0.0119
128	0.0178	0.0059	0.0120
129	0.0180	0.0059	0.0121
130	0.0182	0.0060	0.0122
131	0.0184	0.0060	0.0123
132	0.0185	0.0061	0.0124
133	0.0187	0.0061	0.0126
134	0.0188	0.0062	0.0127
135	0.0191	0.0063	0.0128
136	0.0192	0.0063	0.0129
137	0.0195	0.0064	0.0131
138	0.0196	0.0064	0.0132
139	0.0199	0.0065	0.0133
140	0.0200	0.0066	0.0134
141	0.0203	0.0067	0.0136
142	0.0205	0.0067	0.0137
143	0.0208	0.0068	0.0139
144	0.0209	0.0069	0.0141
145	0.0215	0.0071	0.0144
146	0.0217	0.0071	0.0145
147	0.0220	0.0072	0.0148
148	0.0222	0.0073	0.0149
149	0.0226	0.0074	0.0152
150	0.0228	0.0075	0.0153
151	0.0232	0.0076	0.0156
152	0.0234	0.0077	0.0157
153	0.0238	0.0078	0.0160
154	0.0240	0.0079	0.0162
155	0.0245	0.0081	0.0165
156	0.0248	0.0081	0.0166
157	0.0253	0.0083	0.0170
158	0.0255	0.0084	0.0172

159	0.0261	0.0086	0.0175
160	0.0264	0.0087	0.0177
161	0.0270	0.0089	0.0181
162	0.0273	0.0090	0.0184
163	0.0280	0.0092	0.0188
164	0.0284	0.0093	0.0191
165	0.0291	0.0096	0.0196
166	0.0295	0.0097	0.0198
167	0.0304	0.0100	0.0204
168	0.0308	0.0101	0.0207
169	0.0318	0.0104	0.0214
170	0.0323	0.0106	0.0217
171	0.0334	0.0110	0.0225
172	0.0340	0.0112	0.0229
173	0.0353	0.0116	0.0237
174	0.0360	0.0118	0.0242
175	0.0375	0.0123	0.0252
176	0.0383	0.0126	0.0257
177	0.0401	0.0132	0.0269
178	0.0411	0.0135	0.0276
179	0.0433	0.0142	0.0291
180	0.0445	0.0146	0.0299
181	0.0473	0.0155	0.0318
182	0.0489	0.0160	0.0328
183	0.0525	0.0172	0.0353
184	0.0547	0.0179	0.0367
185	0.0409	0.0134	0.0275
186	0.0436	0.0143	0.0293
187	0.0506	0.0166	0.0340
188	0.0553	0.0181	0.0371
189	0.0687	0.0226	0.0462
190	0.0791	0.0260	0.0532
191	0.1201	0.0262	0.0939
192	0.1743	0.0262	0.1481
193	0.7541	0.0262	0.7279
194	0.0945	0.0262	0.0683
195	0.0611	0.0201	0.0410
196	0.0468	0.0154	0.0314
197	0.0571	0.0187	0.0383
198	0.0506	0.0166	0.0340
199	0.0458	0.0150	0.0308
200	0.0421	0.0138	0.0283
201	0.0392	0.0129	0.0263
202	0.0367	0.0121	0.0247
203	0.0346	0.0114	0.0233
204	0.0329	0.0108	0.0221
205	0.0313	0.0103	0.0210
206	0.0300	0.0098	0.0201
207	0.0288	0.0094	0.0193
208	0.0277	0.0091	0.0186
209	0.0267	0.0088	0.0179
210	0.0258	0.0085	0.0173
211	0.0250	0.0082	0.0168
212	0.0243	0.0080	0.0163
213	0.0236	0.0077	0.0158
214	0.0230	0.0075	0.0154
215	0.0224	0.0073	0.0150
216	0.0218	0.0072	0.0147
217	0.0211	0.0069	0.0142
218	0.0206	0.0068	0.0138
219	0.0202	0.0066	0.0135
220	0.0197	0.0065	0.0133
221	0.0193	0.0063	0.0130
222	0.0190	0.0062	0.0127
223	0.0186	0.0061	0.0125
224	0.0183	0.0060	0.0123
225	0.0179	0.0059	0.0120
226	0.0176	0.0058	0.0118
227	0.0173	0.0057	0.0116
228	0.0171	0.0056	0.0115
229	0.0168	0.0055	0.0113

230	0.0165	0.0054	0.0111
231	0.0163	0.0053	0.0109
232	0.0161	0.0053	0.0108
233	0.0158	0.0052	0.0106
234	0.0156	0.0051	0.0105
235	0.0154	0.0051	0.0103
236	0.0152	0.0050	0.0102
237	0.0150	0.0049	0.0101
238	0.0148	0.0049	0.0099
239	0.0146	0.0048	0.0098
240	0.0145	0.0047	0.0097
241	0.0143	0.0047	0.0096
242	0.0141	0.0046	0.0095
243	0.0140	0.0046	0.0094
244	0.0138	0.0045	0.0093
245	0.0137	0.0045	0.0092
246	0.0135	0.0044	0.0091
247	0.0134	0.0044	0.0090
248	0.0132	0.0043	0.0089
249	0.0131	0.0043	0.0088
250	0.0130	0.0043	0.0087
251	0.0128	0.0042	0.0086
252	0.0127	0.0042	0.0085
253	0.0126	0.0041	0.0085
254	0.0125	0.0041	0.0084
255	0.0124	0.0041	0.0083
256	0.0123	0.0040	0.0082
257	0.0121	0.0040	0.0082
258	0.0120	0.0040	0.0081
259	0.0119	0.0039	0.0080
260	0.0118	0.0039	0.0080
261	0.0117	0.0039	0.0079
262	0.0116	0.0038	0.0078
263	0.0115	0.0038	0.0078
264	0.0115	0.0038	0.0077
265	0.0114	0.0037	0.0076
266	0.0113	0.0037	0.0076
267	0.0112	0.0037	0.0075
268	0.0111	0.0036	0.0075
269	0.0110	0.0036	0.0074
270	0.0109	0.0036	0.0074
271	0.0109	0.0036	0.0073
272	0.0108	0.0035	0.0072
273	0.0107	0.0035	0.0072
274	0.0106	0.0035	0.0071
275	0.0106	0.0035	0.0071
276	0.0105	0.0034	0.0070
277	0.0104	0.0034	0.0070
278	0.0104	0.0034	0.0070
279	0.0103	0.0034	0.0069
280	0.0102	0.0034	0.0069
281	0.0102	0.0033	0.0068
282	0.0101	0.0033	0.0068
283	0.0100	0.0033	0.0067
284	0.0100	0.0033	0.0067
285	0.0099	0.0033	0.0066
286	0.0098	0.0032	0.0066
287	0.0098	0.0032	0.0066
288	0.0097	0.0032	0.0065

Total soil rain loss = 1.83(In)
Total effective rainfall = 4.57(In)
Peak flow rate in flood hydrograph = 35.50(CFS)

+++++

24 - H O U R S T O R M
R u n o f f H y d r o g r a p h

Hydrograph in 5 Minute intervals ((CFS))

Time(h+m)	Volume	Ac.Ft	Q(CFS)	0	10.0	20.0	30.0	40.0
0+ 5	0.0002		0.02	Q				
0+10	0.0013		0.16	Q				
0+15	0.0040		0.40	Q				
0+20	0.0083		0.62	Q				
0+25	0.0132		0.72	Q				
0+30	0.0185		0.76	Q				
0+35	0.0238		0.78	Q				
0+40	0.0292		0.78	Q				
0+45	0.0347		0.79	Q				
0+50	0.0401		0.79	Q				
0+55	0.0456		0.80	Q				
1+ 0	0.0511		0.80	Q				
1+ 5	0.0566		0.80	Q				
1+10	0.0622		0.80	Q				
1+15	0.0677		0.81	Q				
1+20	0.0733		0.81	Q				
1+25	0.0789		0.81	Q				
1+30	0.0845		0.81	Q				
1+35	0.0901		0.82	Q				
1+40	0.0957		0.82	QV				
1+45	0.1014		0.82	QV				
1+50	0.1071		0.82	QV				
1+55	0.1128		0.83	QV				
2+ 0	0.1185		0.83	QV				
2+ 5	0.1242		0.83	QV				
2+10	0.1299		0.83	QV				
2+15	0.1357		0.84	QV				
2+20	0.1415		0.84	QV				
2+25	0.1473		0.84	QV				
2+30	0.1531		0.85	QV				
2+35	0.1590		0.85	QV				
2+40	0.1649		0.85	QV				
2+45	0.1708		0.86	QV				
2+50	0.1767		0.86	QV				
2+55	0.1826		0.86	QV				
3+ 0	0.1885		0.86	Q V				
3+ 5	0.1945		0.87	Q V				
3+10	0.2005		0.87	Q V				
3+15	0.2065		0.87	Q V				
3+20	0.2126		0.88	Q V				
3+25	0.2186		0.88	Q V				
3+30	0.2247		0.88	Q V				
3+35	0.2308		0.89	Q V				
3+40	0.2369		0.89	Q V				
3+45	0.2431		0.89	Q V				
3+50	0.2493		0.90	Q V				
3+55	0.2555		0.90	Q V				
4+ 0	0.2617		0.90	Q V				
4+ 5	0.2679		0.91	Q V				
4+10	0.2742		0.91	Q V				
4+15	0.2805		0.91	Q V				
4+20	0.2868		0.92	Q V				
4+25	0.2931		0.92	Q V				
4+30	0.2995		0.92	Q V				
4+35	0.3059		0.93	Q V				
4+40	0.3123		0.93	Q V				
4+45	0.3188		0.94	Q V				
4+50	0.3252		0.94	Q V				
4+55	0.3317		0.94	Q V				
5+ 0	0.3383		0.95	Q V				
5+ 5	0.3448		0.95	Q V				
5+10	0.3514		0.96	Q V				
5+15	0.3580		0.96	Q V				
5+20	0.3647		0.96	Q V				
5+25	0.3713		0.97	Q V				
5+30	0.3780		0.97	Q V				
5+35	0.3847		0.98	Q V				
5+40	0.3915		0.98	Q V				

5+45	0.3983	0.99	Q	V
5+50	0.4051	0.99	Q	V
5+55	0.4119	0.99	Q	V
6+ 0	0.4188	1.00	Q	V
6+ 5	0.4257	1.00	Q	V
6+10	0.4327	1.01	Q	V
6+15	0.4396	1.01	Q	V
6+20	0.4466	1.02	Q	V
6+25	0.4537	1.02	Q	V
6+30	0.4608	1.03	Q	V
6+35	0.4679	1.03	Q	V
6+40	0.4750	1.04	Q	V
6+45	0.4822	1.04	Q	V
6+50	0.4894	1.05	Q	V
6+55	0.4966	1.05	Q	V
7+ 0	0.5039	1.06	Q	V
7+ 5	0.5113	1.06	Q	V
7+10	0.5186	1.07	Q	V
7+15	0.5260	1.07	Q	V
7+20	0.5335	1.08	Q	V
7+25	0.5409	1.09	Q	V
7+30	0.5484	1.09	Q	V
7+35	0.5560	1.10	Q	V
7+40	0.5636	1.10	Q	V
7+45	0.5712	1.11	Q	V
7+50	0.5789	1.12	Q	V
7+55	0.5867	1.12	Q	V
8+ 0	0.5944	1.13	Q	V
8+ 5	0.6022	1.13	Q	V
8+10	0.6101	1.14	Q	V
8+15	0.6180	1.15	Q	V
8+20	0.6260	1.15	Q	V
8+25	0.6340	1.16	Q	V
8+30	0.6420	1.17	Q	V
8+35	0.6501	1.18	Q	V
8+40	0.6583	1.18	Q	V
8+45	0.6665	1.19	Q	V
8+50	0.6747	1.20	Q	V
8+55	0.6830	1.21	Q	V
9+ 0	0.6914	1.21	Q	V
9+ 5	0.6998	1.22	Q	V
9+10	0.7082	1.23	Q	V
9+15	0.7168	1.24	Q	V
9+20	0.7253	1.25	Q	V
9+25	0.7340	1.25	Q	V
9+30	0.7427	1.26	Q	V
9+35	0.7514	1.27	Q	V
9+40	0.7603	1.28	Q	V
9+45	0.7691	1.29	Q	V
9+50	0.7781	1.30	Q	V
9+55	0.7871	1.31	Q	V
10+ 0	0.7962	1.32	Q	V
10+ 5	0.8053	1.33	Q	V
10+10	0.8146	1.34	Q	V
10+15	0.8239	1.35	Q	V
10+20	0.8332	1.36	Q	V
10+25	0.8427	1.37	Q	V
10+30	0.8522	1.38	Q	V
10+35	0.8618	1.39	Q	V
10+40	0.8715	1.41	Q	V
10+45	0.8812	1.42	Q	V
10+50	0.8911	1.43	Q	V
10+55	0.9010	1.44	Q	V
11+ 0	0.9110	1.45	Q	V
11+ 5	0.9211	1.47	Q	V
11+10	0.9313	1.48	Q	V
11+15	0.9416	1.49	Q	V
11+20	0.9520	1.51	Q	V
11+25	0.9625	1.52	Q	V
11+30	0.9731	1.54	Q	V
11+35	0.9838	1.55	Q	V

11+40	0.9946	1.57	Q	V					
11+45	1.0055	1.59	Q	V					
11+50	1.0166	1.60	Q	V					
11+55	1.0277	1.62	Q	V					
12+ 0	1.0390	1.64	Q	V					
12+ 5	1.0504	1.66	Q	V					
12+10	1.0620	1.68	Q	V					
12+15	1.0737	1.70	Q	V					
12+20	1.0856	1.73	Q	V					
12+25	1.0977	1.75	Q	V					
12+30	1.1099	1.78	Q	V					
12+35	1.1223	1.80	Q	V					
12+40	1.1348	1.82	Q	V					
12+45	1.1476	1.85	Q	V					
12+50	1.1604	1.87	Q	V					
12+55	1.1735	1.90	Q	V					
13+ 0	1.1867	1.92	Q	V					
13+ 5	1.2002	1.95	Q	V					
13+10	1.2138	1.98	Q	V					
13+15	1.2277	2.01	Q	V					
13+20	1.2417	2.04	Q	V					
13+25	1.2560	2.07	Q	V					
13+30	1.2705	2.11	Q	V					
13+35	1.2853	2.15	Q	V					
13+40	1.3004	2.18	Q	V					
13+45	1.3157	2.22	Q	V					
13+50	1.3313	2.27	Q	V					
13+55	1.3472	2.31	Q	V					
14+ 0	1.3634	2.36	Q	V					
14+ 5	1.3800	2.41	Q	V					
14+10	1.3970	2.46	Q	V					
14+15	1.4143	2.52	Q	V					
14+20	1.4321	2.58	Q	V					
14+25	1.4502	2.64	Q	V					
14+30	1.4689	2.71	Q	V					
14+35	1.4881	2.78	Q	V					
14+40	1.5078	2.86	Q	V					
14+45	1.5281	2.95	Q	V					
14+50	1.5491	3.05	Q	V					
14+55	1.5708	3.15	Q	V					
15+ 0	1.5933	3.26	Q	V					
15+ 5	1.6166	3.39	Q	V					
15+10	1.6409	3.53	Q	V					
15+15	1.6663	3.69	Q	V					
15+20	1.6930	3.87	Q	V					
15+25	1.7208	4.03	Q	V					
15+30	1.7484	4.01	Q	V					
15+35	1.7747	3.82	Q	V					
15+40	1.8004	3.73	Q	V					
15+45	1.8276	3.94	Q	V					
15+50	1.8579	4.40	Q	V					
15+55	1.8938	5.21	Q	V					
16+ 0	1.9413	6.89	Q	V					
16+ 5	2.0246	12.10		Q	V				
16+10	2.1977	25.13			V	Q			
16+15	2.4421	35.50			V				Q
16+20	2.6541	30.78				V	Q		
16+25	2.7692	16.72		Q		V			
16+30	2.8339	9.38		Q		V			
16+35	2.8742	5.86		Q		V			
16+40	2.9079	4.90		Q		V			
16+45	2.9387	4.47		Q		V			
16+50	2.9636	3.61		Q		V			
16+55	2.9864	3.32		Q		V			
17+ 0	3.0078	3.10		Q		V			
17+ 5	3.0278	2.91		Q		V			
17+10	3.0467	2.75		Q		V			
17+15	3.0647	2.61		Q		V			
17+20	3.0818	2.49		Q		V			
17+25	3.0982	2.38		Q		V			
17+30	3.1140	2.29		Q		V			

17+35	3.1291	2.20	Q			V
17+40	3.1437	2.12	Q			V
17+45	3.1579	2.06	Q			V
17+50	3.1716	1.99	Q			V
17+55	3.1849	1.93	Q			V
18+ 0	3.1979	1.88	Q			V
18+ 5	3.2105	1.83	Q			V
18+10	3.2227	1.78	Q			V
18+15	3.2347	1.73	Q			V
18+20	3.2463	1.69	Q			V
18+25	3.2576	1.65	Q			V
18+30	3.2687	1.61	Q			V
18+35	3.2795	1.58	Q			V
18+40	3.2902	1.54	Q			V
18+45	3.3006	1.51	Q			V
18+50	3.3108	1.49	Q			V
18+55	3.3209	1.46	Q			V
19+ 0	3.3308	1.43	Q			V
19+ 5	3.3405	1.41	Q			V
19+10	3.3500	1.39	Q			V
19+15	3.3594	1.36	Q			V
19+20	3.3686	1.34	Q			V
19+25	3.3777	1.32	Q			V
19+30	3.3867	1.30	Q			V
19+35	3.3956	1.28	Q			V
19+40	3.4043	1.27	Q			V
19+45	3.4129	1.25	Q			V
19+50	3.4214	1.23	Q			V
19+55	3.4297	1.22	Q			V
20+ 0	3.4380	1.20	Q			V
20+ 5	3.4462	1.19	Q			V
20+10	3.4542	1.17	Q			V
20+15	3.4622	1.16	Q			V
20+20	3.4701	1.14	Q			V
20+25	3.4778	1.13	Q			V
20+30	3.4855	1.12	Q			V
20+35	3.4932	1.11	Q			V
20+40	3.5007	1.09	Q			V
20+45	3.5081	1.08	Q			V
20+50	3.5155	1.07	Q			V
20+55	3.5228	1.06	Q			V
21+ 0	3.5300	1.05	Q			V
21+ 5	3.5372	1.04	Q			V
21+10	3.5443	1.03	Q			V
21+15	3.5513	1.02	Q			V
21+20	3.5582	1.01	Q			V
21+25	3.5651	1.00	Q			V
21+30	3.5719	0.99	Q			V
21+35	3.5787	0.98	Q			V
21+40	3.5854	0.97	Q			V
21+45	3.5921	0.96	Q			V
21+50	3.5986	0.96	Q			V
21+55	3.6052	0.95	Q			V
22+ 0	3.6117	0.94	Q			V
22+ 5	3.6181	0.93	Q			V
22+10	3.6245	0.93	Q			V
22+15	3.6308	0.92	Q			V
22+20	3.6371	0.91	Q			V
22+25	3.6433	0.90	Q			V
22+30	3.6495	0.90	Q			V
22+35	3.6556	0.89	Q			V
22+40	3.6617	0.88	Q			V
22+45	3.6677	0.88	Q			V
22+50	3.6737	0.87	Q			V
22+55	3.6797	0.87	Q			V
23+ 0	3.6856	0.86	Q			V
23+ 5	3.6915	0.85	Q			V
23+10	3.6973	0.85	Q			V
23+15	3.7031	0.84	Q			V
23+20	3.7089	0.84	Q			V
23+25	3.7146	0.83	Q			V

23+30	3.7203	0.82	Q				V
23+35	3.7259	0.82	Q				V
23+40	3.7315	0.81	Q				V
23+45	3.7371	0.81	Q				V
23+50	3.7426	0.80	Q				V
23+55	3.7481	0.80	Q				V
24+ 0	3.7536	0.79	Q				V
24+ 5	3.7589	0.76	Q				V
24+10	3.7632	0.63	Q				V
24+15	3.7658	0.38	Q				V
24+20	3.7669	0.16	Q				V
24+25	3.7674	0.06	Q				V
24+30	3.7675	0.02	Q				V
24+35	3.7676	0.01	Q				V
24+40	3.7676	0.01	Q				V



$3.7676 \times 43,560 = 164,117 \text{ CF}$

**UNIT HYDROGRAPH METHOD-100YR, 24HR STORM EVENT
EXISTING CONDITION**

Unit Hydrograph Analysis

Copyright (c) CIVILCADD/CIVILDESIGN, 1989 - 2018, Version 9.0

Study date 10/05/21

San Bernardino County Synthetic Unit Hydrology Method
Manual date - August 1986

Program License Serial Number 6484

UH METHOD
100YR 24HR STORM EVENT
EXISTING CONDITION

Storm Event Year = 100

Antecedent Moisture Condition = 3

English (in-lb) Input Units Used

English Rainfall Data (Inches) Input Values Used

English Units used in output format

Area averaged rainfall intensity isohyetal data:

Sub-Area (Ac.)	Duration (hours)	Isohyetal (In)
Rainfall data for year 100		
9.90	1	1.59

Rainfall data for year 100		
9.90	6	3.50

Rainfall data for year 100		
9.90	24	6.40

***** Area-averaged max loss rate, Fm *****

SCS curve No.(AMCII)	SCS curve NO.(AMC 3)	Area (Ac.)	Area Fraction	Fp(Fig C6) (In/Hr)	Ap (dec.)	Fm (In/Hr)
46.0	66.0	9.90	1.000	0.593	1.000	0.593

Area-averaged adjusted loss rate Fm (In/Hr) = 0.593

***** Area-Averaged low loss rate fraction, Yb *****

Area (Ac.)	Area Fract	SCS CN (AMC2)	SCS CN (AMC3)	S	Pervious Yield Fr
9.90	1.000	46.0	66.0	5.15	0.428

Area-averaged catchment yield fraction, Y = 0.428

Area-averaged low loss fraction, Yb = 0.572

Direct entry of lag time by user

Watershed area = 9.90(Ac.)

Catchment Lag time = 0.338 hours
 Unit interval = 5.000 minutes
 Unit interval percentage of lag time = 24.6548
 Hydrograph baseflow = 0.00(CFS)
 Average maximum watershed loss rate(Fm) = 0.550(In/Hr)
 Average low loss rate fraction (Yb) = 0.572 (decimal)
 Note: user entry of the Fm value
 VALLEY UNDEVELOPED S-Graph Selected
 Computed peak 5-minute rainfall = 0.754(In)
 Computed peak 30-minute rainfall = 1.291(In)
 Specified peak 1-hour rainfall = 1.590(In)
 Computed peak 3-hour rainfall = 2.579(In)
 Specified peak 6-hour rainfall = 3.500(In)
 Specified peak 24-hour rainfall = 6.400(In)

Rainfall depth area reduction factors:
 Using a total area of 9.90(Ac.) (Ref: fig. E-4)

5-minute factor = 1.000	Adjusted rainfall = 0.754(In)
30-minute factor = 1.000	Adjusted rainfall = 1.291(In)
1-hour factor = 1.000	Adjusted rainfall = 1.589(In)
3-hour factor = 1.000	Adjusted rainfall = 2.579(In)
6-hour factor = 1.000	Adjusted rainfall = 3.500(In)
24-hour factor = 1.000	Adjusted rainfall = 6.400(In)

U n i t H y d r o g r a p h

+-----+
 Interval 'S' Graph Unit Hydrograph
 Number Mean values ((CFS))
 -----+

(K = 119.73 (CFS))

1	2.263	2.709
2	9.729	8.939
3	22.980	15.866
4	40.131	20.534
5	55.596	18.516
6	65.323	11.647
7	71.571	7.481
8	75.764	5.020
9	79.144	4.046
10	81.918	3.322
11	84.278	2.826
12	86.310	2.432
13	87.987	2.008
14	89.470	1.776
15	90.822	1.618
16	91.915	1.308
17	92.910	1.192
18	93.707	0.953
19	94.482	0.928
20	95.223	0.887
21	95.912	0.824
22	96.462	0.659
23	96.981	0.621
24	97.429	0.537
25	97.851	0.505
26	98.202	0.420
27	98.527	0.389
28	98.780	0.303
29	99.027	0.295
30	99.273	0.295
31	99.520	0.295
32	99.766	0.295
33	100.000	0.280

-----+
 Peak Unit Adjusted mass rainfall Unit rainfall
 Number (In) (In)
 1 0.7541 0.7541

2	0.9284	0.1743
3	1.0485	0.1201
4	1.1430	0.0945
5	1.2222	0.0791
6	1.2909	0.0687
7	1.3520	0.0611
8	1.4072	0.0553
9	1.4579	0.0506
10	1.5047	0.0468
11	1.5483	0.0436
12	1.5893	0.0409
13	1.6463	0.0571
14	1.7010	0.0547
15	1.7535	0.0525
16	1.8041	0.0506
17	1.8530	0.0489
18	1.9002	0.0473
19	1.9460	0.0458
20	1.9905	0.0445
21	2.0338	0.0433
22	2.0759	0.0421
23	2.1170	0.0411
24	2.1571	0.0401
25	2.1963	0.0392
26	2.2346	0.0383
27	2.2720	0.0375
28	2.3087	0.0367
29	2.3447	0.0360
30	2.3800	0.0353
31	2.4147	0.0346
32	2.4487	0.0340
33	2.4821	0.0334
34	2.5150	0.0329
35	2.5473	0.0323
36	2.5792	0.0318
37	2.6105	0.0313
38	2.6413	0.0308
39	2.6717	0.0304
40	2.7017	0.0300
41	2.7312	0.0295
42	2.7603	0.0291
43	2.7891	0.0288
44	2.8175	0.0284
45	2.8455	0.0280
46	2.8732	0.0277
47	2.9005	0.0273
48	2.9275	0.0270
49	2.9542	0.0267
50	2.9806	0.0264
51	3.0068	0.0261
52	3.0326	0.0258
53	3.0581	0.0255
54	3.0834	0.0253
55	3.1084	0.0250
56	3.1332	0.0248
57	3.1577	0.0245
58	3.1820	0.0243
59	3.2060	0.0240
60	3.2299	0.0238
61	3.2535	0.0236
62	3.2768	0.0234
63	3.3000	0.0232
64	3.3230	0.0230
65	3.3457	0.0228
66	3.3683	0.0226
67	3.3907	0.0224
68	3.4129	0.0222
69	3.4349	0.0220
70	3.4567	0.0218
71	3.4784	0.0217
72	3.4999	0.0215

73	3.5210	0.0211
74	3.5419	0.0209
75	3.5627	0.0208
76	3.5833	0.0206
77	3.6037	0.0205
78	3.6240	0.0203
79	3.6442	0.0202
80	3.6642	0.0200
81	3.6840	0.0199
82	3.7038	0.0197
83	3.7234	0.0196
84	3.7428	0.0195
85	3.7622	0.0193
86	3.7814	0.0192
87	3.8005	0.0191
88	3.8194	0.0190
89	3.8383	0.0188
90	3.8570	0.0187
91	3.8756	0.0186
92	3.8941	0.0185
93	3.9124	0.0184
94	3.9307	0.0183
95	3.9488	0.0182
96	3.9669	0.0180
97	3.9848	0.0179
98	4.0027	0.0178
99	4.0204	0.0177
100	4.0380	0.0176
101	4.0555	0.0175
102	4.0730	0.0174
103	4.0903	0.0173
104	4.1076	0.0172
105	4.1247	0.0171
106	4.1418	0.0171
107	4.1587	0.0170
108	4.1756	0.0169
109	4.1924	0.0168
110	4.2091	0.0167
111	4.2257	0.0166
112	4.2422	0.0165
113	4.2587	0.0164
114	4.2751	0.0164
115	4.2914	0.0163
116	4.3076	0.0162
117	4.3237	0.0161
118	4.3397	0.0161
119	4.3557	0.0160
120	4.3716	0.0159
121	4.3874	0.0158
122	4.4032	0.0157
123	4.4189	0.0157
124	4.4345	0.0156
125	4.4500	0.0155
126	4.4655	0.0155
127	4.4809	0.0154
128	4.4962	0.0153
129	4.5114	0.0153
130	4.5266	0.0152
131	4.5418	0.0151
132	4.5568	0.0151
133	4.5718	0.0150
134	4.5868	0.0149
135	4.6016	0.0149
136	4.6164	0.0148
137	4.6312	0.0147
138	4.6459	0.0147
139	4.6605	0.0146
140	4.6751	0.0146
141	4.6896	0.0145
142	4.7040	0.0145
143	4.7184	0.0144

144	4.7328	0.0143
145	4.7470	0.0143
146	4.7613	0.0142
147	4.7754	0.0142
148	4.7896	0.0141
149	4.8036	0.0141
150	4.8176	0.0140
151	4.8316	0.0140
152	4.8455	0.0139
153	4.8593	0.0139
154	4.8731	0.0138
155	4.8869	0.0138
156	4.9006	0.0137
157	4.9142	0.0137
158	4.9279	0.0136
159	4.9414	0.0136
160	4.9549	0.0135
161	4.9684	0.0135
162	4.9818	0.0134
163	4.9952	0.0134
164	5.0085	0.0133
165	5.0217	0.0133
166	5.0350	0.0132
167	5.0482	0.0132
168	5.0613	0.0131
169	5.0744	0.0131
170	5.0874	0.0131
171	5.1004	0.0130
172	5.1134	0.0130
173	5.1263	0.0129
174	5.1392	0.0129
175	5.1520	0.0128
176	5.1648	0.0128
177	5.1776	0.0128
178	5.1903	0.0127
179	5.2030	0.0127
180	5.2156	0.0126
181	5.2282	0.0126
182	5.2408	0.0126
183	5.2533	0.0125
184	5.2658	0.0125
185	5.2782	0.0124
186	5.2906	0.0124
187	5.3030	0.0124
188	5.3153	0.0123
189	5.3276	0.0123
190	5.3399	0.0123
191	5.3521	0.0122
192	5.3643	0.0122
193	5.3764	0.0121
194	5.3885	0.0121
195	5.4006	0.0121
196	5.4126	0.0120
197	5.4246	0.0120
198	5.4366	0.0120
199	5.4485	0.0119
200	5.4604	0.0119
201	5.4723	0.0119
202	5.4842	0.0118
203	5.4960	0.0118
204	5.5077	0.0118
205	5.5195	0.0117
206	5.5312	0.0117
207	5.5428	0.0117
208	5.5545	0.0116
209	5.5661	0.0116
210	5.5777	0.0116
211	5.5892	0.0115
212	5.6007	0.0115
213	5.6122	0.0115
214	5.6237	0.0115

215	5.6351	0.0114
216	5.6465	0.0114
217	5.6579	0.0114
218	5.6692	0.0113
219	5.6805	0.0113
220	5.6918	0.0113
221	5.7030	0.0112
222	5.7143	0.0112
223	5.7255	0.0112
224	5.7366	0.0112
225	5.7478	0.0111
226	5.7589	0.0111
227	5.7699	0.0111
228	5.7810	0.0111
229	5.7920	0.0110
230	5.8030	0.0110
231	5.8140	0.0110
232	5.8249	0.0109
233	5.8359	0.0109
234	5.8467	0.0109
235	5.8576	0.0109
236	5.8685	0.0108
237	5.8793	0.0108
238	5.8901	0.0108
239	5.9008	0.0108
240	5.9115	0.0107
241	5.9223	0.0107
242	5.9329	0.0107
243	5.9436	0.0107
244	5.9542	0.0106
245	5.9649	0.0106
246	5.9754	0.0106
247	5.9860	0.0106
248	5.9965	0.0105
249	6.0071	0.0105
250	6.0176	0.0105
251	6.0280	0.0105
252	6.0385	0.0104
253	6.0489	0.0104
254	6.0593	0.0104
255	6.0697	0.0104
256	6.0800	0.0104
257	6.0903	0.0103
258	6.1006	0.0103
259	6.1109	0.0103
260	6.1212	0.0103
261	6.1314	0.0102
262	6.1416	0.0102
263	6.1518	0.0102
264	6.1620	0.0102
265	6.1722	0.0102
266	6.1823	0.0101
267	6.1924	0.0101
268	6.2025	0.0101
269	6.2126	0.0101
270	6.2226	0.0100
271	6.2326	0.0100
272	6.2426	0.0100
273	6.2526	0.0100
274	6.2626	0.0100
275	6.2725	0.0099
276	6.2824	0.0099
277	6.2923	0.0099
278	6.3022	0.0099
279	6.3121	0.0099
280	6.3219	0.0098
281	6.3317	0.0098
282	6.3415	0.0098
283	6.3513	0.0098
284	6.3611	0.0098
285	6.3708	0.0097

286	6.3805	0.0097
287	6.3902	0.0097
288	6.3999	0.0097

Unit Period (number)	Unit Rainfall (In)	Unit Soil-Loss (In)	Effective Rainfall (In)
1	0.0097	0.0055	0.0041
2	0.0097	0.0055	0.0042
3	0.0097	0.0056	0.0042
4	0.0098	0.0056	0.0042
5	0.0098	0.0056	0.0042
6	0.0098	0.0056	0.0042
7	0.0099	0.0056	0.0042
8	0.0099	0.0056	0.0042
9	0.0099	0.0057	0.0042
10	0.0099	0.0057	0.0043
11	0.0100	0.0057	0.0043
12	0.0100	0.0057	0.0043
13	0.0100	0.0057	0.0043
14	0.0101	0.0058	0.0043
15	0.0101	0.0058	0.0043
16	0.0101	0.0058	0.0043
17	0.0102	0.0058	0.0044
18	0.0102	0.0058	0.0044
19	0.0102	0.0059	0.0044
20	0.0103	0.0059	0.0044
21	0.0103	0.0059	0.0044
22	0.0103	0.0059	0.0044
23	0.0104	0.0059	0.0044
24	0.0104	0.0059	0.0045
25	0.0104	0.0060	0.0045
26	0.0105	0.0060	0.0045
27	0.0105	0.0060	0.0045
28	0.0105	0.0060	0.0045
29	0.0106	0.0061	0.0045
30	0.0106	0.0061	0.0045
31	0.0107	0.0061	0.0046
32	0.0107	0.0061	0.0046
33	0.0107	0.0061	0.0046
34	0.0108	0.0062	0.0046
35	0.0108	0.0062	0.0046
36	0.0108	0.0062	0.0046
37	0.0109	0.0062	0.0047
38	0.0109	0.0062	0.0047
39	0.0110	0.0063	0.0047
40	0.0110	0.0063	0.0047
41	0.0111	0.0063	0.0047
42	0.0111	0.0063	0.0047
43	0.0111	0.0064	0.0048
44	0.0112	0.0064	0.0048
45	0.0112	0.0064	0.0048
46	0.0112	0.0064	0.0048
47	0.0113	0.0065	0.0048
48	0.0113	0.0065	0.0049
49	0.0114	0.0065	0.0049
50	0.0114	0.0065	0.0049
51	0.0115	0.0066	0.0049
52	0.0115	0.0066	0.0049
53	0.0116	0.0066	0.0050
54	0.0116	0.0066	0.0050
55	0.0117	0.0067	0.0050
56	0.0117	0.0067	0.0050
57	0.0118	0.0067	0.0050
58	0.0118	0.0067	0.0051
59	0.0119	0.0068	0.0051
60	0.0119	0.0068	0.0051
61	0.0120	0.0068	0.0051
62	0.0120	0.0069	0.0051
63	0.0121	0.0069	0.0052

64	0.0121	0.0069	0.0052
65	0.0122	0.0070	0.0052
66	0.0122	0.0070	0.0052
67	0.0123	0.0070	0.0053
68	0.0123	0.0070	0.0053
69	0.0124	0.0071	0.0053
70	0.0124	0.0071	0.0053
71	0.0125	0.0072	0.0054
72	0.0126	0.0072	0.0054
73	0.0126	0.0072	0.0054
74	0.0127	0.0072	0.0054
75	0.0128	0.0073	0.0055
76	0.0128	0.0073	0.0055
77	0.0129	0.0074	0.0055
78	0.0129	0.0074	0.0055
79	0.0130	0.0074	0.0056
80	0.0131	0.0075	0.0056
81	0.0131	0.0075	0.0056
82	0.0132	0.0075	0.0056
83	0.0133	0.0076	0.0057
84	0.0133	0.0076	0.0057
85	0.0134	0.0077	0.0057
86	0.0135	0.0077	0.0058
87	0.0136	0.0078	0.0058
88	0.0136	0.0078	0.0058
89	0.0137	0.0078	0.0059
90	0.0138	0.0079	0.0059
91	0.0139	0.0079	0.0059
92	0.0139	0.0080	0.0060
93	0.0140	0.0080	0.0060
94	0.0141	0.0080	0.0060
95	0.0142	0.0081	0.0061
96	0.0142	0.0081	0.0061
97	0.0143	0.0082	0.0061
98	0.0144	0.0082	0.0062
99	0.0145	0.0083	0.0062
100	0.0146	0.0083	0.0062
101	0.0147	0.0084	0.0063
102	0.0147	0.0084	0.0063
103	0.0149	0.0085	0.0064
104	0.0149	0.0085	0.0064
105	0.0151	0.0086	0.0064
106	0.0151	0.0086	0.0065
107	0.0153	0.0087	0.0065
108	0.0153	0.0088	0.0066
109	0.0155	0.0088	0.0066
110	0.0155	0.0089	0.0067
111	0.0157	0.0090	0.0067
112	0.0157	0.0090	0.0067
113	0.0159	0.0091	0.0068
114	0.0160	0.0091	0.0068
115	0.0161	0.0092	0.0069
116	0.0162	0.0093	0.0069
117	0.0164	0.0094	0.0070
118	0.0164	0.0094	0.0070
119	0.0166	0.0095	0.0071
120	0.0167	0.0096	0.0072
121	0.0169	0.0097	0.0072
122	0.0170	0.0097	0.0073
123	0.0171	0.0098	0.0073
124	0.0172	0.0099	0.0074
125	0.0174	0.0100	0.0075
126	0.0175	0.0100	0.0075
127	0.0177	0.0101	0.0076
128	0.0178	0.0102	0.0076
129	0.0180	0.0103	0.0077
130	0.0182	0.0104	0.0078
131	0.0184	0.0105	0.0079
132	0.0185	0.0106	0.0079
133	0.0187	0.0107	0.0080
134	0.0188	0.0108	0.0081

135	0.0191	0.0109	0.0082
136	0.0192	0.0110	0.0082
137	0.0195	0.0111	0.0083
138	0.0196	0.0112	0.0084
139	0.0199	0.0114	0.0085
140	0.0200	0.0114	0.0086
141	0.0203	0.0116	0.0087
142	0.0205	0.0117	0.0088
143	0.0208	0.0119	0.0089
144	0.0209	0.0120	0.0090
145	0.0215	0.0123	0.0092
146	0.0217	0.0124	0.0093
147	0.0220	0.0126	0.0094
148	0.0222	0.0127	0.0095
149	0.0226	0.0129	0.0097
150	0.0228	0.0130	0.0097
151	0.0232	0.0132	0.0099
152	0.0234	0.0134	0.0100
153	0.0238	0.0136	0.0102
154	0.0240	0.0137	0.0103
155	0.0245	0.0140	0.0105
156	0.0248	0.0142	0.0106
157	0.0253	0.0145	0.0108
158	0.0255	0.0146	0.0109
159	0.0261	0.0149	0.0112
160	0.0264	0.0151	0.0113
161	0.0270	0.0154	0.0116
162	0.0273	0.0156	0.0117
163	0.0280	0.0160	0.0120
164	0.0284	0.0162	0.0122
165	0.0291	0.0167	0.0125
166	0.0295	0.0169	0.0126
167	0.0304	0.0174	0.0130
168	0.0308	0.0176	0.0132
169	0.0318	0.0182	0.0136
170	0.0323	0.0185	0.0138
171	0.0334	0.0191	0.0143
172	0.0340	0.0195	0.0146
173	0.0353	0.0202	0.0151
174	0.0360	0.0206	0.0154
175	0.0375	0.0214	0.0160
176	0.0383	0.0219	0.0164
177	0.0401	0.0229	0.0172
178	0.0411	0.0235	0.0176
179	0.0433	0.0247	0.0185
180	0.0445	0.0254	0.0191
181	0.0473	0.0270	0.0202
182	0.0489	0.0279	0.0209
183	0.0525	0.0300	0.0225
184	0.0547	0.0313	0.0234
185	0.0409	0.0234	0.0175
186	0.0436	0.0250	0.0187
187	0.0506	0.0289	0.0217
188	0.0553	0.0316	0.0237
189	0.0687	0.0393	0.0294
190	0.0791	0.0453	0.0339
191	0.1201	0.0458	0.0743
192	0.1743	0.0458	0.1285
193	0.7541	0.0458	0.7083
194	0.0945	0.0458	0.0487
195	0.0611	0.0349	0.0262
196	0.0468	0.0268	0.0200
197	0.0571	0.0326	0.0244
198	0.0506	0.0289	0.0217
199	0.0458	0.0262	0.0196
200	0.0421	0.0241	0.0180
201	0.0392	0.0224	0.0168
202	0.0367	0.0210	0.0157
203	0.0346	0.0198	0.0148
204	0.0329	0.0188	0.0141
205	0.0313	0.0179	0.0134

206	0.0300	0.0171	0.0128
207	0.0288	0.0164	0.0123
208	0.0277	0.0158	0.0119
209	0.0267	0.0153	0.0114
210	0.0258	0.0148	0.0111
211	0.0250	0.0143	0.0107
212	0.0243	0.0139	0.0104
213	0.0236	0.0135	0.0101
214	0.0230	0.0131	0.0098
215	0.0224	0.0128	0.0096
216	0.0218	0.0125	0.0094
217	0.0211	0.0121	0.0090
218	0.0206	0.0118	0.0088
219	0.0202	0.0115	0.0086
220	0.0197	0.0113	0.0084
221	0.0193	0.0111	0.0083
222	0.0190	0.0108	0.0081
223	0.0186	0.0106	0.0080
224	0.0183	0.0104	0.0078
225	0.0179	0.0103	0.0077
226	0.0176	0.0101	0.0075
227	0.0173	0.0099	0.0074
228	0.0171	0.0098	0.0073
229	0.0168	0.0096	0.0072
230	0.0165	0.0095	0.0071
231	0.0163	0.0093	0.0070
232	0.0161	0.0092	0.0069
233	0.0158	0.0090	0.0068
234	0.0156	0.0089	0.0067
235	0.0154	0.0088	0.0066
236	0.0152	0.0087	0.0065
237	0.0150	0.0086	0.0064
238	0.0148	0.0085	0.0063
239	0.0146	0.0084	0.0063
240	0.0145	0.0083	0.0062
241	0.0143	0.0082	0.0061
242	0.0141	0.0081	0.0060
243	0.0140	0.0080	0.0060
244	0.0138	0.0079	0.0059
245	0.0137	0.0078	0.0058
246	0.0135	0.0077	0.0058
247	0.0134	0.0076	0.0057
248	0.0132	0.0076	0.0057
249	0.0131	0.0075	0.0056
250	0.0130	0.0074	0.0056
251	0.0128	0.0073	0.0055
252	0.0127	0.0073	0.0054
253	0.0126	0.0072	0.0054
254	0.0125	0.0071	0.0053
255	0.0124	0.0071	0.0053
256	0.0123	0.0070	0.0052
257	0.0121	0.0069	0.0052
258	0.0120	0.0069	0.0052
259	0.0119	0.0068	0.0051
260	0.0118	0.0068	0.0051
261	0.0117	0.0067	0.0050
262	0.0116	0.0067	0.0050
263	0.0115	0.0066	0.0049
264	0.0115	0.0066	0.0049
265	0.0114	0.0065	0.0049
266	0.0113	0.0064	0.0048
267	0.0112	0.0064	0.0048
268	0.0111	0.0064	0.0048
269	0.0110	0.0063	0.0047
270	0.0109	0.0063	0.0047
271	0.0109	0.0062	0.0047
272	0.0108	0.0062	0.0046
273	0.0107	0.0061	0.0046
274	0.0106	0.0061	0.0046
275	0.0106	0.0060	0.0045
276	0.0105	0.0060	0.0045

277	0.0104	0.0060	0.0045
278	0.0104	0.0059	0.0044
279	0.0103	0.0059	0.0044
280	0.0102	0.0058	0.0044
281	0.0102	0.0058	0.0043
282	0.0101	0.0058	0.0043
283	0.0100	0.0057	0.0043
284	0.0100	0.0057	0.0043
285	0.0099	0.0057	0.0042
286	0.0098	0.0056	0.0042
287	0.0098	0.0056	0.0042
288	0.0097	0.0056	0.0042

Total soil rain loss = 3.19(In)
Total effective rainfall = 3.21(In)
Peak flow rate in flood hydrograph = 19.81(CFS)

+++++
24 - H O U R S T O R M
R u n o f f H y d r o g r a p h

Hydrograph in 5 Minute intervals ((CFS))

Time(h+m)	Volume Ac.Ft	Q(CFS)	0	5.0	10.0	15.0	20.0
0+ 5	0.0001	0.01	Q				
0+10	0.0004	0.05	Q				
0+15	0.0012	0.11	Q				
0+20	0.0026	0.20	Q				
0+25	0.0045	0.28	Q				
0+30	0.0067	0.33	Q				
0+35	0.0092	0.36	Q				
0+40	0.0118	0.38	Q				
0+45	0.0145	0.40	Q				
0+50	0.0174	0.41	Q				
0+55	0.0203	0.43	Q				
1+ 0	0.0233	0.44	Q				
1+ 5	0.0264	0.45	Q				
1+10	0.0296	0.46	Q				
1+15	0.0327	0.46	Q				
1+20	0.0360	0.47	Q				
1+25	0.0393	0.48	Q				
1+30	0.0426	0.48	Q				
1+35	0.0460	0.49	Q				
1+40	0.0493	0.49	Q				
1+45	0.0528	0.50	Q				
1+50	0.0562	0.50	VQ				
1+55	0.0597	0.51	VQ				
2+ 0	0.0632	0.51	VQ				
2+ 5	0.0668	0.51	Q				
2+10	0.0703	0.52	Q				
2+15	0.0739	0.52	Q				
2+20	0.0775	0.52	Q				
2+25	0.0812	0.53	Q				
2+30	0.0848	0.53	Q				
2+35	0.0885	0.53	Q				
2+40	0.0922	0.54	Q				
2+45	0.0959	0.54	Q				
2+50	0.0996	0.54	Q				
2+55	0.1034	0.54	Q				
3+ 0	0.1071	0.54	Q				
3+ 5	0.1109	0.55	Q				
3+10	0.1146	0.55	Q				
3+15	0.1184	0.55	Q				
3+20	0.1222	0.55	Q				
3+25	0.1261	0.55	Q				
3+30	0.1299	0.56	Q				
3+35	0.1337	0.56	QV				
3+40	0.1376	0.56	QV				

3+45	0.1415	0.56	QV				
3+50	0.1453	0.56	QV				
3+55	0.1492	0.57	QV				
4+ 0	0.1532	0.57	QV				
4+ 5	0.1571	0.57	QV				
4+10	0.1610	0.57	QV				
4+15	0.1650	0.58	QV				
4+20	0.1690	0.58	QV				
4+25	0.1730	0.58	QV				
4+30	0.1770	0.58	QV				
4+35	0.1810	0.58	QV				
4+40	0.1850	0.59	QV				
4+45	0.1891	0.59	QV				
4+50	0.1932	0.59	QV				
4+55	0.1972	0.59	QV				
5+ 0	0.2013	0.60	Q V				
5+ 5	0.2055	0.60	Q V				
5+10	0.2096	0.60	Q V				
5+15	0.2138	0.60	Q V				
5+20	0.2179	0.61	Q V				
5+25	0.2221	0.61	Q V				
5+30	0.2263	0.61	Q V				
5+35	0.2305	0.61	Q V				
5+40	0.2348	0.62	Q V				
5+45	0.2391	0.62	Q V				
5+50	0.2433	0.62	Q V				
5+55	0.2476	0.62	Q V				
6+ 0	0.2520	0.63	Q V				
6+ 5	0.2563	0.63	Q V				
6+10	0.2606	0.63	Q V				
6+15	0.2650	0.64	Q V				
6+20	0.2694	0.64	Q V				
6+25	0.2738	0.64	Q V				
6+30	0.2783	0.64	Q V				
6+35	0.2827	0.65	Q V				
6+40	0.2872	0.65	Q V				
6+45	0.2917	0.65	Q V				
6+50	0.2962	0.66	Q V				
6+55	0.3008	0.66	Q V				
7+ 0	0.3054	0.66	Q V				
7+ 5	0.3100	0.67	Q V				
7+10	0.3146	0.67	Q V				
7+15	0.3192	0.67	Q V				
7+20	0.3239	0.68	Q V				
7+25	0.3286	0.68	Q V				
7+30	0.3333	0.68	Q V				
7+35	0.3380	0.69	Q V				
7+40	0.3428	0.69	Q V				
7+45	0.3475	0.69	Q V				
7+50	0.3523	0.70	Q V				
7+55	0.3572	0.70	Q V				
8+ 0	0.3620	0.71	Q V				
8+ 5	0.3669	0.71	Q V				
8+10	0.3719	0.71	Q V				
8+15	0.3768	0.72	Q V				
8+20	0.3818	0.72	Q V				
8+25	0.3868	0.73	Q V				
8+30	0.3918	0.73	Q V				
8+35	0.3969	0.73	Q V				
8+40	0.4020	0.74	Q V				
8+45	0.4071	0.74	Q V				
8+50	0.4122	0.75	Q V				
8+55	0.4174	0.75	Q V				
9+ 0	0.4226	0.76	Q V				
9+ 5	0.4279	0.76	Q V				
9+10	0.4332	0.77	Q V				
9+15	0.4385	0.77	Q V				
9+20	0.4438	0.78	Q V				
9+25	0.4492	0.78	Q V				
9+30	0.4547	0.79	Q V				
9+35	0.4601	0.79	Q V				

9+40	0.4656	0.80	Q	V				
9+45	0.4712	0.80	Q	V				
9+50	0.4767	0.81	Q	V				
9+55	0.4823	0.82	Q	V				
10+ 0	0.4880	0.82	Q	V				
10+ 5	0.4937	0.83	Q	V				
10+10	0.4994	0.83	Q	V				
10+15	0.5052	0.84	Q	V				
10+20	0.5110	0.85	Q	V				
10+25	0.5169	0.85	Q	V				
10+30	0.5228	0.86	Q	V				
10+35	0.5288	0.87	Q	V				
10+40	0.5348	0.87	Q	V				
10+45	0.5408	0.88	Q	V				
10+50	0.5470	0.89	Q	V				
10+55	0.5531	0.89	Q	V				
11+ 0	0.5593	0.90	Q	V				
11+ 5	0.5656	0.91	Q	V				
11+10	0.5719	0.92	Q	V				
11+15	0.5783	0.93	Q	V				
11+20	0.5847	0.93	Q	V				
11+25	0.5912	0.94	Q	V				
11+30	0.5978	0.95	Q	V				
11+35	0.6044	0.96	Q	V				
11+40	0.6111	0.97	Q	V				
11+45	0.6178	0.98	Q	V				
11+50	0.6246	0.99	Q	V				
11+55	0.6315	1.00	Q	V				
12+ 0	0.6384	1.01	Q	V				
12+ 5	0.6455	1.02	Q	V				
12+10	0.6526	1.03	Q	V				
12+15	0.6598	1.05	Q	V				
12+20	0.6671	1.06	Q	V				
12+25	0.6745	1.07	Q	V				
12+30	0.6820	1.09	Q	V				
12+35	0.6895	1.10	Q	V				
12+40	0.6972	1.11	Q	V				
12+45	0.7050	1.13	Q	V				
12+50	0.7129	1.14	Q	V				
12+55	0.7208	1.16	Q	V				
13+ 0	0.7289	1.17	Q	V				
13+ 5	0.7371	1.19	Q	V				
13+10	0.7454	1.21	Q	V				
13+15	0.7539	1.22	Q	V				
13+20	0.7624	1.24	Q	V				
13+25	0.7711	1.26	Q	V				
13+30	0.7799	1.28	Q	V				
13+35	0.7889	1.30	Q	V				
13+40	0.7980	1.32	Q	V				
13+45	0.8073	1.35	Q	V				
13+50	0.8167	1.37	Q	V				
13+55	0.8263	1.39	Q	V				
14+ 0	0.8361	1.42	Q	V				
14+ 5	0.8461	1.45	Q	V				
14+10	0.8562	1.48	Q	V				
14+15	0.8666	1.51	Q	V				
14+20	0.8772	1.54	Q	V				
14+25	0.8881	1.58	Q	V				
14+30	0.8992	1.61	Q	V				
14+35	0.9105	1.65	Q	V				
14+40	0.9222	1.69	Q	V				
14+45	0.9342	1.74	Q	V				
14+50	0.9465	1.79	Q	V				
14+55	0.9592	1.84	Q	V				
15+ 0	0.9723	1.90	Q	V				
15+ 5	0.9859	1.97	Q	V				
15+10	0.9999	2.04	Q	V				
15+15	1.0145	2.12	Q	V				
15+20	1.0298	2.21	Q	V				
15+25	1.0455	2.29	Q	V				
15+30	1.0616	2.33	Q	V				

15+35	1.0777	2.34	Q		V			
15+40	1.0937	2.33	Q		V			
15+45	1.1100	2.37	Q		V			
15+50	1.1273	2.51	Q		V			
15+55	1.1469	2.84	Q		V			
16+ 0	1.1717	3.61	Q		V			
16+ 5	1.2169	6.55		Q	V			
16+10	1.2982	11.82			V	Q		
16+15	1.4156	17.04			V		Q	
16+20	1.5520	19.81			V			Q
16+25	1.6733	17.60			V	V		Q
16+30	1.7578	12.27			V	Q		
16+35	1.8191	8.90			V	V		
16+40	1.8668	6.92		Q	V	V		
16+45	1.9082	6.01	Q	Q	V	V		
16+50	1.9448	5.31		Q	V	V		
16+55	1.9776	4.77		Q	V	V		
17+ 0	2.0073	4.32			V	V		
17+ 5	2.0340	3.87		Q	V	V		
17+10	2.0586	3.57		Q	V	V		
17+15	2.0815	3.33		Q	V	V		
17+20	2.1022	3.00		Q	V	V		
17+25	2.1216	2.81		Q	V	V		
17+30	2.1393	2.57		Q	V	V		
17+35	2.1564	2.47		Q	V	V		
17+40	2.1727	2.37		Q	V	V		
17+45	2.1882	2.25		Q	V	V		
17+50	2.2024	2.07		Q	V	V		
17+55	2.2161	1.98	Q		V	V		
18+ 0	2.2289	1.87	Q		V	V		
18+ 5	2.2412	1.79	Q		V	V		
18+10	2.2528	1.68	Q		V	V		
18+15	2.2639	1.61	Q		V	V		
18+20	2.2743	1.51	Q		V	V		
18+25	2.2844	1.47	Q		V	V		
18+30	2.2942	1.43	Q		V	V		
18+35	2.3038	1.40	Q		V	V		
18+40	2.3131	1.35	Q		V	V		
18+45	2.3220	1.28	Q		V	V		
18+50	2.3293	1.06	Q		V	V		
18+55	2.3364	1.03	Q		V	V		
19+ 0	2.3434	1.01	Q		V	V		
19+ 5	2.3502	0.99	Q		V	V		
19+10	2.3568	0.97	Q		V	V		
19+15	2.3633	0.95	Q		V	V		
19+20	2.3697	0.93	Q		V	V		
19+25	2.3760	0.91	Q		V	V		
19+30	2.3822	0.89	Q		V	V		
19+35	2.3882	0.88	Q		V	V		
19+40	2.3942	0.86	Q		V	V		
19+45	2.4000	0.85	Q		V	V		
19+50	2.4058	0.84	Q		V	V		
19+55	2.4114	0.82	Q		V	V		
20+ 0	2.4170	0.81	Q		V	V		
20+ 5	2.4225	0.80	Q		V	V		
20+10	2.4280	0.79	Q		V	V		
20+15	2.4333	0.78	Q		V	V		
20+20	2.4386	0.77	Q		V	V		
20+25	2.4438	0.76	Q		V	V		
20+30	2.4490	0.75	Q		V	V		
20+35	2.4541	0.74	Q		V	V		
20+40	2.4591	0.73	Q		V	V		
20+45	2.4641	0.72	Q		V	V		
20+50	2.4690	0.71	Q		V	V		
20+55	2.4739	0.71	Q		V	V		
21+ 0	2.4787	0.70	Q		V	V		
21+ 5	2.4834	0.69	Q		V	V		
21+10	2.4881	0.68	Q		V	V		
21+15	2.4928	0.68	Q		V	V		
21+20	2.4974	0.67	Q		V	V		
21+25	2.5020	0.66	Q		V	V		

21+30	2.5065	0.66	Q				V
21+35	2.5110	0.65	Q				V
21+40	2.5154	0.64	Q				V
21+45	2.5198	0.64	Q				V
21+50	2.5241	0.63	Q				V
21+55	2.5284	0.63	Q				V
22+ 0	2.5327	0.62	Q				V
22+ 5	2.5369	0.62	Q				V
22+10	2.5411	0.61	Q				V
22+15	2.5453	0.60	Q				V
22+20	2.5494	0.60	Q				V
22+25	2.5535	0.59	Q				V
22+30	2.5576	0.59	Q				V
22+35	2.5616	0.59	Q				V
22+40	2.5656	0.58	Q				V
22+45	2.5696	0.58	Q				V
22+50	2.5735	0.57	Q				V
22+55	2.5774	0.57	Q				V
23+ 0	2.5813	0.56	Q				V
23+ 5	2.5852	0.56	Q				V
23+10	2.5890	0.55	Q				V
23+15	2.5928	0.55	Q				V
23+20	2.5966	0.55	Q				V
23+25	2.6003	0.54	Q				V
23+30	2.6040	0.54	Q				V
23+35	2.6077	0.54	Q				V
23+40	2.6114	0.53	Q				V
23+45	2.6150	0.53	Q				V
23+50	2.6186	0.53	Q				V
23+55	2.6222	0.52	Q				V
24+ 0	2.6258	0.52	Q				V
24+ 5	2.6293	0.50	Q				V
24+10	2.6325	0.46	Q				V
24+15	2.6352	0.40	Q				V
24+20	2.6373	0.31	Q				V
24+25	2.6389	0.23	Q				V
24+30	2.6401	0.18	Q				V
24+35	2.6411	0.15	Q				V
24+40	2.6420	0.13	Q				V
24+45	2.6428	0.11	Q				V
24+50	2.6434	0.09	Q				V
24+55	2.6440	0.08	Q				V
25+ 0	2.6445	0.07	Q				V
25+ 5	2.6449	0.06	Q				V
25+10	2.6453	0.05	Q				V
25+15	2.6456	0.05	Q				V
25+20	2.6459	0.04	Q				V
25+25	2.6461	0.04	Q				V
25+30	2.6463	0.03	Q				V
25+35	2.6465	0.03	Q				V
25+40	2.6467	0.02	Q				V
25+45	2.6469	0.02	Q				V
25+50	2.6470	0.02	Q				V
25+55	2.6471	0.02	Q				V
26+ 0	2.6472	0.01	Q				V
26+ 5	2.6472	0.01	Q				V
26+10	2.6473	0.01	Q				V
26+15	2.6474	0.01	Q				V
26+20	2.6474	0.01	Q				V
26+25	2.6474	0.00	Q				V
26+30	2.6475	0.00	Q				V
26+35	2.6475	0.00	Q				V
26+40	2.6475	0.00	Q				V

2.6475*43,560=115,325 CF

HCOC MITIGATION CALCULATION

THE SITE IS NOT HCOC EXEMPT FOR WATER DRAINAGE ASPECT.

PEAK RUNOFF RATE IN DEVELOPED CONDITION: 34.3 CFS
(100-YR STORM EVENT)

PEAK RUNOFF RATE IN EXISTING CONDITION: 21.0 CFS
(100-YR STORM EVENT)

INCREASED FLOW IN DEVELOPED CONDITION: 13.3 CFS

RUNOFF VOLUME IN DEVELOPED CONDITION: 3.7676 AC-FT ~ 164,117 CF
(100-YR, 24-HR STORM EVENT)

RUNOFF VOLUME IN EXISTING CONDITION: 2.6475 AC-FT ~ 115,325 CF
(100-YR, 24-HR STORM EVENT)

REQUIRED RETENTION VOLUME FOR HCOC MITIGATION (100-YR 24-HR STORM
EVENT): 48,117 CF (164,117 CF - 115,324 CF)

RETENTION/INFILTRATION VOLUME PROVIDED WITH 7-BELOW SURFACE
CONTECH RET/INF. CHAMBER SYSTEM: $(7 \times 7,159) = 50,218$ CF
(RET/INFILTRATION CAPACITY OF EACH CONTECH CHAMBER SYSTEM: 7,174 CF)

**HCOC CONDITION WILL BE MITTIGATED BY FULL RETENTION/INFILTRATION
PROVIDING BY THE CONTECH CHAMBER SYSTEM 1 THROUGH 7.**

**BY RETENTION/INFILTRATION OF THE INCREASED WATER VOLUME UTILIZING 7-
BELOW SURFACE CONTECH CHAMBER SYSTEM AND BY ATTENUATION OF THE
PEAK FLOW THROUGH THE THE SYSTEM, THE INCREASED FLOW RATE WILL BE
SUBSTANTIALLY REDUCED TO EXISTING CONDITION.
THEREFORE HCOC CONDITION WILL BE ELIMATED.**

(Refer to the following sheets for Contech Chamber System capacity
Calculation)

PROJECT SUMMARY

CALCULATION DETAILS

- LOADING = HS20 & HS25
- APPROX. LINEAR FOOTAGE = 174 lf.

STORAGE SUMMARY

- STORAGE VOLUME REQUIRED = 7,050 cf.
- PIPE STORAGE VOLUME = 4,920 cf.
- BACKFILL STORAGE VOLUME = 2,255 cf.
- TOTAL STORAGE PROVIDED = 7,174 cf.

COMBINED CAPACITY OF THE PROPOSED 7-CHAMBERS: $7 * 7,174 = 50,218$ CF
 TOTAL FOOT PRINT: $7 * (54'x24') = 9,072$ SF

PIPE DETAILS

- DIAMETER = 72 IN.
- CORRUGATION = 5x1
- GAGE = 16
- COATING = ALT2
- WALL TYPE = Perforated
- BARRELL SPACING = 36 IN.

BACKFILL DETAILS

- WIDTH AT ENDS = 12 IN.
- ABOVE PIPE = 6 IN.
- WIDTH AT SIDES = 12 IN.
- BELOW PIPE = 9 IN.

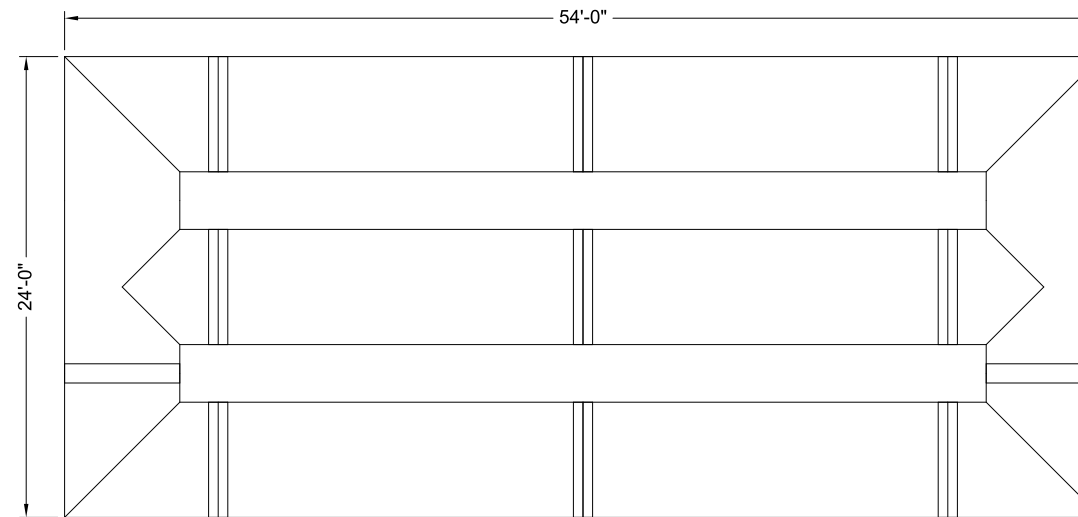

NOTES

- ALL RISER AND STUB DIMENSIONS ARE TO CENTERLINE. ALL ELEVATIONS, DIMENSIONS, AND LOCATIONS OF RISERS AND INLETS, SHALL BE VERIFIED BY THE ENGINEER OF RECORD PRIOR TO RELEASING FOR FABRICATION.
- ALL FITTINGS AND REINFORCEMENT COMPLY WITH ASTM A998.
- ALL RISERS AND STUBS ARE $2\frac{2}{3}''$ x $\frac{1}{2}''$ CORRUGATION AND 16 GAGE UNLESS OTHERWISE NOTED.
- RISERS TO BE FIELD TRIMMED TO GRADE.
- QUANTITY OF PIPE SHOWN DOES NOT PROVIDE EXTRA PIPE FOR CONNECTING THE SYSTEM TO EXISTING PIPE OR DRAINAGE STRUCTURES. OUR SYSTEM AS DETAILED PROVIDES NOMINAL INLET AND/OR OUTLET PIPE STUB FOR CONNECTION TO EXISTING DRAINAGE FACILITIES. IF ADDITIONAL PIPE IS NEEDED IT IS THE RESPONSIBILITY OF THE CONTRACTOR.
- BAND TYPE TO BE DETERMINED UPON FINAL DESIGN.
- THE PROJECT SUMMARY IS REFLECTIVE OF THE DYODS DESIGN, QUANTITIES ARE APPROX. AND SHOULD BE VERIFIED UPON FINAL DESIGN AND APPROVAL. FOR EXAMPLE, TOTAL EXCAVATION DOES NOT CONSIDER ALL VARIABLES SUCH AS SHORING AND ONLY ACCOUNTS FOR MATERIAL WITHIN THE ESTIMATED EXCAVATION FOOTPRINT.
- THESE DRAWINGS ARE FOR CONCEPTUAL PURPOSES AND DO NOT REFLECT ANY LOCAL PREFERENCES OR REGULATIONS. PLEASE CONTACT YOUR LOCAL CONTECH REP FOR MODIFICATIONS.

ASSEMBLY
 SCALE: 1" = 10'

C:\EXPORT\TEMPLATES\CMP_V5.DWG 10/18/2019 10:02 AM

<small>The design and information shown on this drawing is provided as a service to the project owner, engineer and contractor by Contech Engineered Solutions LLC ("Contech"). Neither this drawing, nor any part thereof, may be used, reproduced or modified in any manner without the prior written consent of Contech. Failure to comply is done at the user's own risk and Contech expressly disclaims any liability or responsibility for such use.</small>		
<small>If discrepancies between the supplied information upon which the drawing is based and actual field conditions are encountered as site work progresses, these discrepancies must be reported to Contech immediately for re-evaluation of the design. Contech accepts no liability for designs based on missing, incomplete or inaccurate information supplied by others.</small>		
DATE	REVISION DESCRIPTION	BY

CONTECH
 ENGINEERED SOLUTIONS LLC
 www.ContechES.com

9025 Centre Pointe Dr., Suite 400, West Chester, OH 45069
 800-338-1122 513-645-7000 513-645-7993 FAX

CONTECH
 CMP DETENTION SYSTEMS

CONTECH
 DYODS
 DRAWING

DY010714 Warmington
 Retention System-Medical Center Dr
 Fontana, CA
 DETENTION SYSTEM

PROJECT No.: 6662	SEQ. No.: 10714	DATE: 9/30/2021
DESIGNED: DYO	DRAWN: DYO	
CHECKED: DYO	APPROVED: DYO	
SHEET NO.:		D1

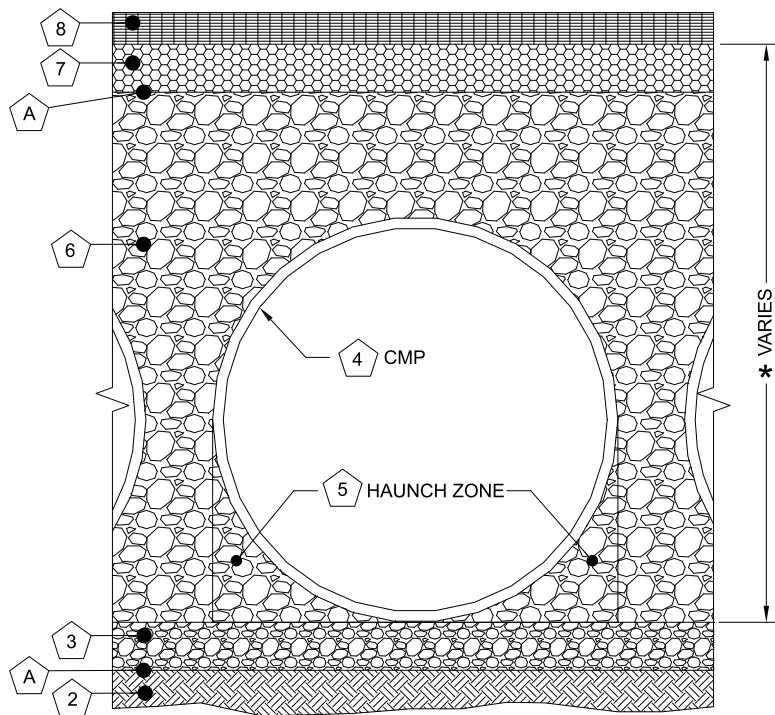

Infiltration Systems - CMP Infiltration & CMP Perforated Drainage Pipe			
Material Location	Description	Material Designation	Designation
8	Rigid or Flexible Pavement (if applicable)		
7	Road Base (if applicable)		
A	Geotextile Layer	Non-Woven Geotextile CONTECH C-40 or C-45	Engineer Decision for consideration to prevent soil migration into varying soil types. Wrap the trench only.
6	Backfill	Infiltration pipe systems have a pipe perforation sized of 3/8" diameter. An open graded, free draining stone, with a particle size of 1/2" - 2 1/2" diameter is recommended.	AASHTO M 145-A-1 or AASHTO M 43 - 3, 4 Material shall be worked into the pipe haunches by means of shovel-slicing, rodding, air-tamper, vibratory rod, or other effective methods. Compaction of all placed fill material is necessary and shall be considered adequate when no further yielding of the material is observed under the compactor, or under foot, and the Project Engineer or his representative is satisfied with the level of compaction"
3	Bedding Stone	Well graded granular bedding material w/maximum particle size of 3"	AASHTO M43 - 3,357,4,467, 5, 56, 57 For soil aggregates larger than 3/8" a dedicated bedding layer is not required for CMP. Pipe may be placed on the trench bottom comprised of native suitable well graded & granular material. For Arch pipes it is recommended to be shaped to a relatively flat bottom or fine-grade the foundation to a slight v-shape. Soil aggregates less than 3/8" and unsuitable material should be over-excavated and re-placed with a 4"-6" layer of well graded & granular stone per the material designation.
A	Geotextile Layer	None	None Contech does not recommend geotextiles be placed under the invert of infiltration systems due to the propensity for geotextiles to clog over time.

* Note: The listed AASHTO designations are for gradation only. The stone must also be angular and clean.

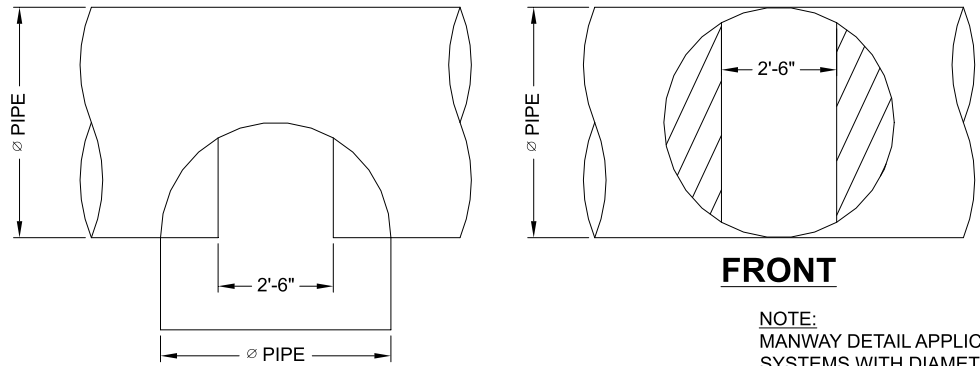

FRONT

NOTE: MANWAY DETAIL APPLICABLE FOR CMP SYSTEMS WITH DIAMETERS 48" AND LARGER. MANWAYS MAY BE REQUIRED ON SMALLER SYSTEMS DEPENDING ON ACTUAL SITE SPECIFIC CONDITIONS.

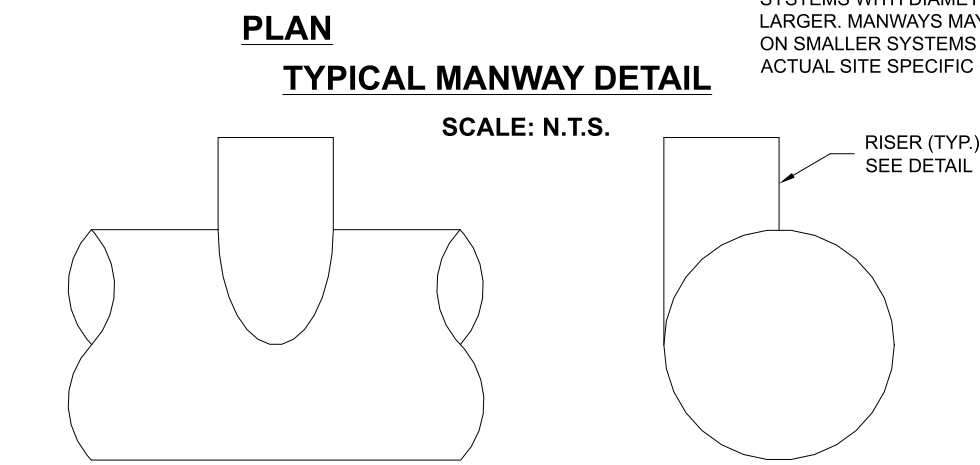

END

NOTE: LADDERS ARE OPTIONAL AND ARE NOT REQUIRED FOR ALL SYSTEMS.

- 1 MINIMUM WIDTH DEPENDS ON SITE CONDITIONS AND ENGINEERING JUDGEMENT.
- 2 PRIOR TO PLACING THE BEDDING, THE FOUNDATION MUST BE CONSTRUCTED TO A UNIFORM AND STABLE GRADE. IN THE EVENT THAT UNSUITABLE FOUNDATION MATERIALS ARE ENCOUNTERED DURING EXCAVATION, THEY SHALL BE REMOVED AND BROUGHT BACK TO THE GRADE WITH A FILL MATERIAL AS APPROVED BY THE ENGINEER.
- 5 HAUNCH ZONE MATERIAL SHALL BE PLACED AND UNIFORMLY COMPACTED WITHOUT SOFT SPOTS.

BACKFILL
MATERIAL SHALL BE PLACED IN 8"-10" MAXIMUM LIFTS. INADEQUATE COMPACTION CAN LEAD TO EXCESSIVE DEFLECTIONS WITHIN THE SYSTEM AND SETTLEMENT OF THE SOILS OVER THE SYSTEM. BACKFILL SHALL BE PLACED SUCH THAT THERE IS NO MORE THAN A TWO-LIFT DIFFERENTIAL BETWEEN THE SIDES OF ANY PIPE IN THE SYSTEM AT ALL TIMES DURING THE BACKFILL PROCESS. BACKFILL SHALL BE ADVANCED ALONG THE LENGTH OF THE SYSTEM AT THE SAME RATE TO AVOID DIFFERENTIAL LOADING ON ANY PIPES IN THE SYSTEM.

EQUIPMENT USED TO PLACE AND COMPACT THE BACKFILL SHALL BE OF A SIZE AND TYPE SO AS NOT TO DISTORT, DAMAGE, OR DISPLACE THE PIPE. ATTENTION MUST BE GIVEN TO PROVIDING ADEQUATE MINIMUM COVER FOR SUCH EQUIPMENT. MAINTAIN BALANCED LOADING ON ALL PIPES IN THE SYSTEM DURING ALL SUCH OPERATIONS.

OTHER ALTERNATE BACKFILL MATERIAL MAY BE ALLOWED DEPENDING ON SITE SPECIFIC CONDITIONS. REFER TO TYPICAL BACKFILL DETAIL FOR MATERIAL REQUIRED.

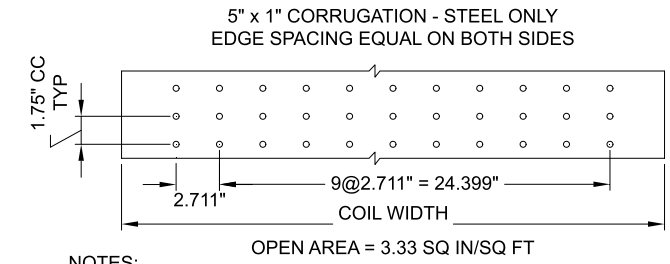
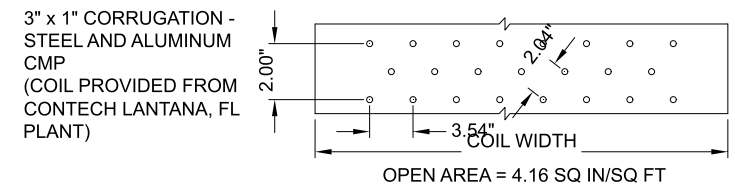
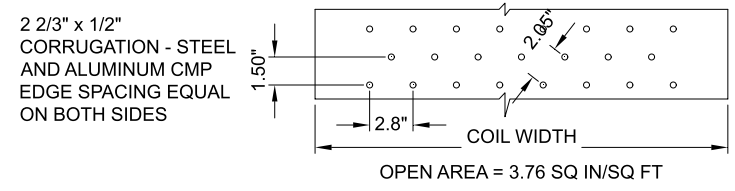

- NOTES:
- PERFORATIONS MEET AASHTO AND ASTM SPECIFICATIONS.
 - PERFORATION OPEN AREA PER SQUARE FOOT OF PIPE IS BASED ON THE NOMINAL DIAMETER AND LENGTH OF PIPE.
 - ALL DIMENSIONS ARE SUBJECT TO MANUFACTURING TOLERANCES.
 - ALL HOLES \varnothing 3/8".

TYPICAL PERFORATION DETAIL
SCALE: N.T.S.

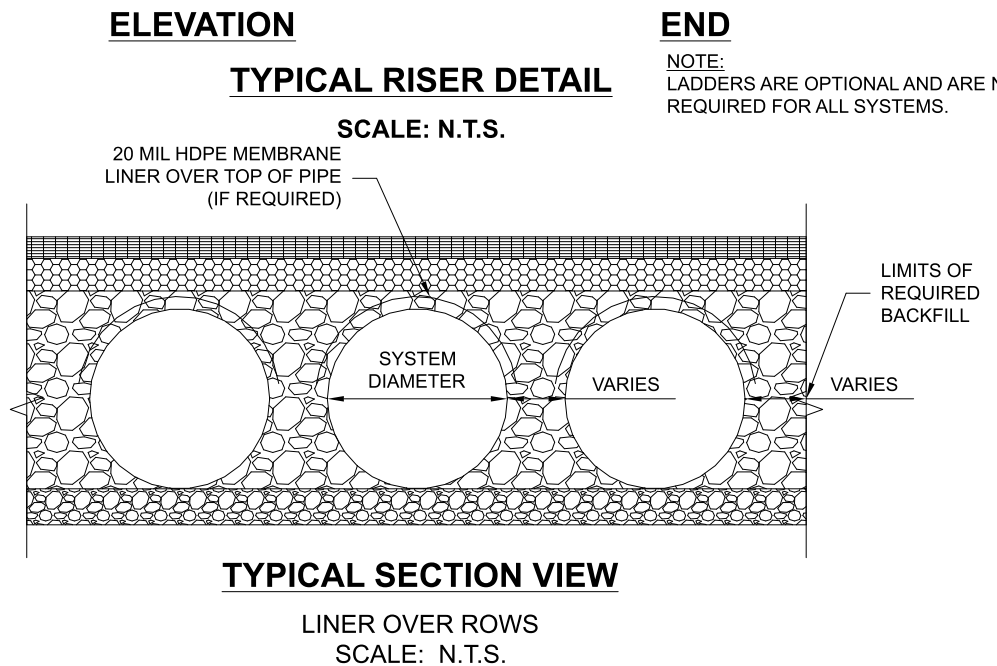

TYPICAL SECTION VIEW
SCALE: N.T.S.

NOTE: IF SALTING AGENTS FOR SNOW AND ICE REMOVAL ARE USED ON OR NEAR THE PROJECT, AN HDPE MEMBRANE LINER IS RECOMMENDED WITH THE SYSTEM. THE IMPERMEABLE LINER IS INTENDED TO HELP PROTECT THE SYSTEM FROM THE POTENTIAL ADVERSE EFFECTS THAT MAY RESULT FROM A CHANGE IN THE SURROUNDING ENVIRONMENT OVER A PERIOD OF TIME. PLEASE REFER TO THE CORRUGATED METAL PIPE DETENTION DESIGN GUIDE FOR ADDITIONAL INFORMATION.

C:\EXPORT\TEMPLATES\CMP_V5.DWG 10/18/2019 10:02 AM

The design and information shown on this drawing is provided as a service to the project owner, engineer and contractor by Contech Engineered Solutions LLC ("Contech"). Neither this drawing, nor any part thereof, may be used, reproduced or modified in any manner without the prior written consent of Contech. Failure to comply is done at the user's own risk and Contech expressly disclaims any liability or responsibility for such use.

If discrepancies between the supplied information upon which the drawing is based and actual field conditions are encountered as site work progresses, these discrepancies must be reported to Contech immediately for re-evaluation of the design. Contech accepts no liability for designs based on missing, incomplete or inaccurate information supplied by others.

DATE	REVISION DESCRIPTION	BY

CONTECH
ENGINEERED SOLUTIONS LLC
www.ContechES.com
9025 Centre Pointe Dr., Suite 400, West Chester, OH 45069
800-338-1122 513-645-7000 513-645-7993 FAX

CONTECH
CMP DETENTION SYSTEMS
CONTECH
DYODS
DRAWING

DY010714 Warmington
Retention System-Medical Center Dr
Fontana, CA
DETENTION SYSTEM

PROJECT No.: 6662	SEQ. No.: 10714	DATE: 9/30/2021
DESIGNED: DYO	DRAWN: DYO	
CHECKED: DYO	APPROVED: DYO	
SHEET NO.:		D2

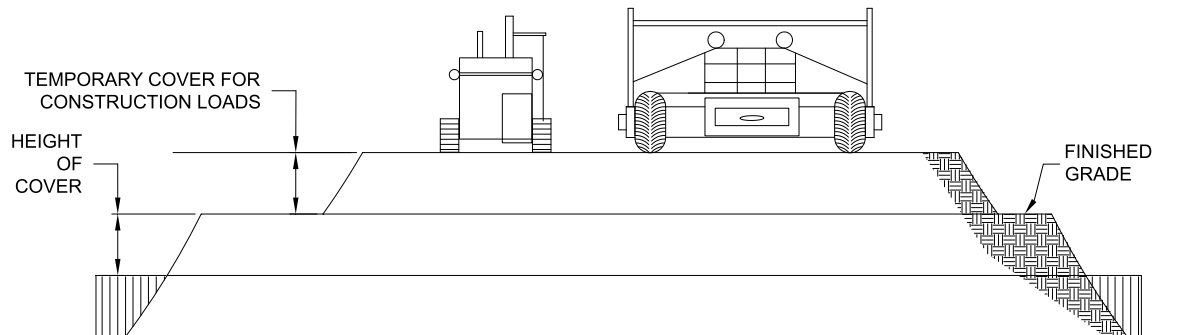

CONSTRUCTION LOADS

FOR TEMPORARY CONSTRUCTION VEHICLE LOADS, AN EXTRA AMOUNT OF COMPACTED COVER MAY BE REQUIRED OVER THE TOP OF THE PIPE. THE HEIGHT-OF-COVER SHALL MEET THE MINIMUM REQUIREMENTS SHOWN IN THE TABLE BELOW. THE USE OF HEAVY CONSTRUCTION EQUIPMENT NECESSITATES GREATER PROTECTION FOR THE PIPE THAN FINISHED GRADE COVER MINIMUMS FOR NORMAL HIGHWAY TRAFFIC.

PIPE SPAN, INCHES	AXLE LOADS (kips)			
	18-50	50-75	75-110	110-150
	MINIMUM COVER (FT)			
12-42	2.0	2.5	3.0	3.0
48-72	3.0	3.0	3.5	4.0
78-120	3.0	3.5	4.0	4.0
126-144	3.5	4.0	4.5	4.5

*MINIMUM COVER MAY VARY, DEPENDING ON LOCAL CONDITIONS. THE CONTRACTOR MUST PROVIDE THE ADDITIONAL COVER REQUIRED TO AVOID DAMAGE TO THE PIPE. MINIMUM COVER IS MEASURED FROM THE TOP OF THE PIPE TO THE TOP OF THE MAINTAINED CONSTRUCTION ROADWAY SURFACE.

CONSTRUCTION LOADING DIAGRAM

SCALE: N.T.S.

SPECIFICATION FOR DESIGNED DETENTION SYSTEM:

SCOPE

THIS SPECIFICATION COVERS THE MANUFACTURE AND INSTALLATION OF THE DESIGNED DETENTION SYSTEM DETAILED IN THE PROJECT PLANS.

MATERIAL

THE MATERIAL SHALL CONFORM TO THE APPLICABLE REQUIREMENTS LISTED BELOW:

ALUMINIZED TYPE 2 STEEL COILS SHALL CONFORM TO THE APPLICABLE REQUIREMENTS OF AASHTO M-274 OR ASTM A-92.

THE GALVANIZED STEEL COILS SHALL CONFORM TO THE APPLICABLE REQUIREMENTS OF AASHTO M-218 OR ASTM A-929.

THE POLYMER COATED STEEL COILS SHALL CONFORM TO THE APPLICABLE REQUIREMENTS OF AASHTO M-246 OR ASTM A-742.

THE ALUMINUM COILS SHALL CONFORM TO THE APPLICABLE REQUIREMENTS OF AASHTO M-197 OR ASTM B-744.

CONSTRUCTION LOADS

CONSTRUCTION LOADS MAY BE HIGHER THAN FINAL LOADS. FOLLOW THE MANUFACTURER'S OR NCSPE GUIDELINES.

PIPE

THE PIPE SHALL BE MANUFACTURED IN ACCORDANCE TO THE APPLICABLE REQUIREMENTS LISTED BELOW:

ALUMINIZED TYPE 2: AASHTO M-36 OR ASTM A-760

GALVANIZED: AASHTO M-36 OR ASTM A-760

POLYMER COATED: AASHTO M-245 OR ASTM A-762

ALUMINUM: AASHTO M-196 OR ASTM B-745

HANDLING AND ASSEMBLY

SHALL BE IN ACCORDANCE WITH NCSP'S (NATIONAL CORRUGATED STEEL PIPE ASSOCIATION) FOR ALUMINIZED TYPE 2, GALVANIZED OR POLYMER COATED STEEL. SHALL BE IN ACCORDANCE WITH THE MANUFACTURER'S RECOMMENDATIONS FOR ALUMINUM PIPE.

INSTALLATION

SHALL BE IN ACCORDANCE WITH AASHTO STANDARD SPECIFICATIONS FOR HIGHWAY BRIDGES, SECTION 26, DIVISION II DIVISION II OR ASTM A-798 (FOR ALUMINIZED TYPE 2, GALVANIZED OR POLYMER COATED STEEL) OR ASTM B-788 (FOR ALUMINUM PIPE) AND IN CONFORMANCE WITH THE PROJECT PLANS AND SPECIFICATIONS. IF THERE ARE ANY INCONSISTENCIES OR CONFLICTS THE CONTRACTOR SHOULD DISCUSS AND RESOLVE WITH THE SITE ENGINEER.

IT IS ALWAYS THE RESPONSIBILITY OF THE CONTRACTOR TO FOLLOW OSHA GUIDELINES FOR SAFE PRACTICES.

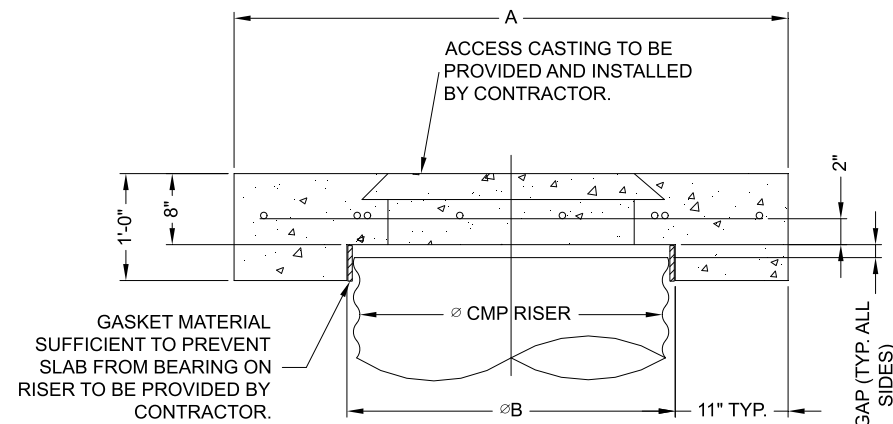

SECTION VIEW

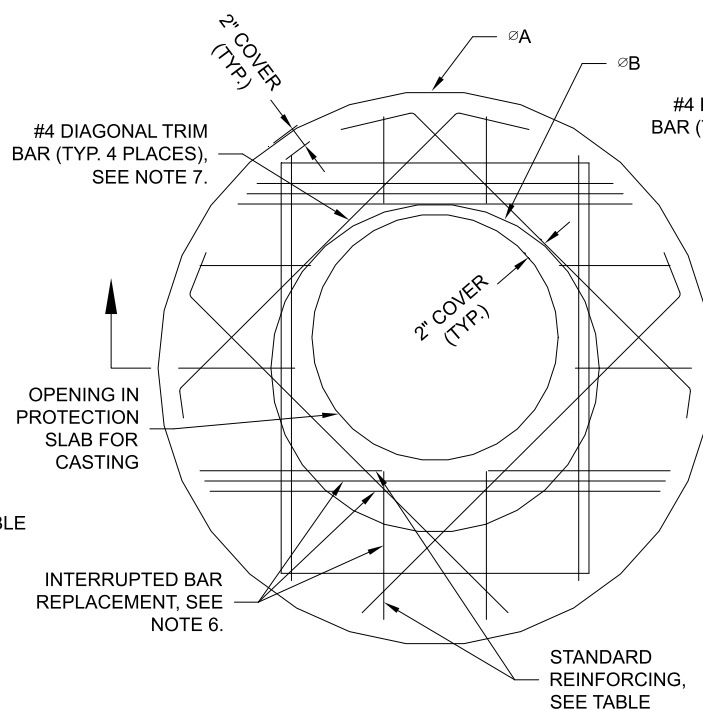

ROUND OPTION PLAN VIEW

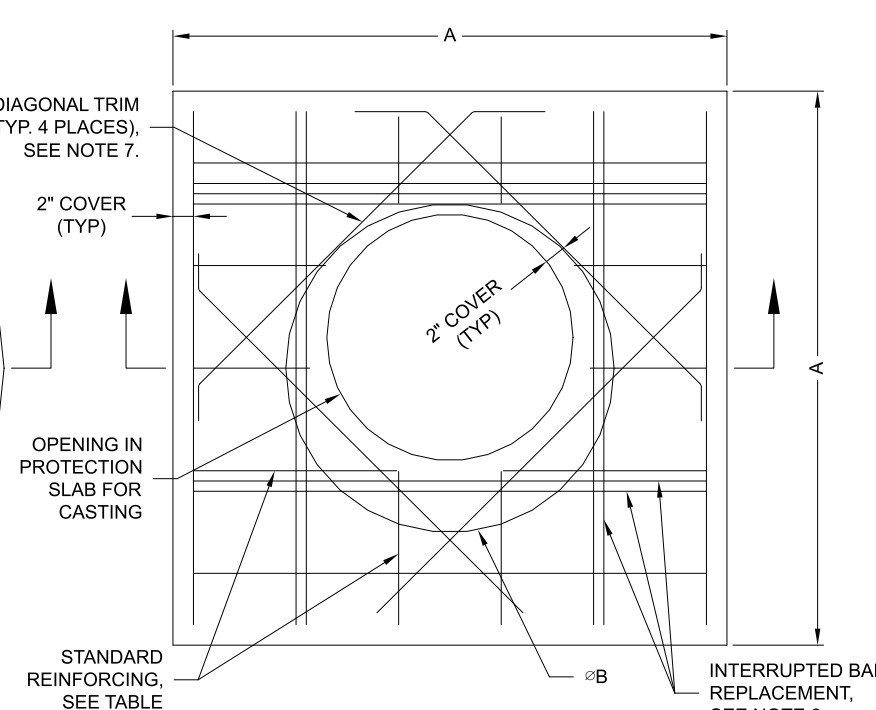

SQUARE OPTION PLAN VIEW

NOTES:

- DESIGN IN ACCORDANCE WITH AASHTO, 17th EDITION.
- DESIGN LOAD HS25.
- EARTH COVER = 1' MAX.
- CONCRETE STRENGTH = 3,500 psi
- REINFORCING STEEL = ASTM A615, GRADE 60.
- PROVIDE ADDITIONAL REINFORCING AROUND OPENINGS EQUAL TO THE BARS INTERRUPTED, HALF EACH SIDE. ADDITIONAL BARS TO BE IN THE SAME PLANE.
- TRIM OPENING WITH DIAGONAL #4 BARS, EXTEND BARS A MINIMUM OF 12" BEYOND OPENING, BEND BARS AS REQUIRED TO MAINTAIN BAR COVER.
- PROTECTION SLAB AND ALL MATERIALS TO BE PROVIDED AND INSTALLED BY CONTRACTOR.
- DETAIL DESIGN BY DELTA ENGINEERING, BINGHAMTON, NY.

MANHOLE CAP DETAIL

SCALE: N.T.S.

Ø CMP RISER	A	Ø B	REINFORCING	**BEARING PRESSURE (PSF)
24"	Ø 4' 4'X4'	26"	#5 @ 12" OCEW #5 @ 12" OCEW	2,410 1,780
30"	Ø 4'-6" 4'-6" X 4'-6"	32"	#5 @ 12" OCEW #5 @ 12" OCEW	2,120 1,530
36"	Ø 5' X 5'	38"	#5 @ 10" OCEW #5 @ 10" OCEW	1,890 1,350
42"	Ø 5'-6" 5'-6" X 5'-6"	44"	#5 @ 10" OCEW #5 @ 9" OCEW	1,720 1,210
48"	Ø 6' X 6'	50"	#5 @ 9" OCEW #5 @ 8" OCEW	1,600 1,100

** ASSUMED SOIL BEARING CAPACITY

C:\EXPORT\TEMPLATES\CMP_V5.DWG 10/18/2019 10:02 AM

NOTE:
THESE DRAWINGS ARE FOR CONCEPTUAL PURPOSES AND DO NOT REFLECT ANY LOCAL PREFERENCES OR REGULATIONS. PLEASE CONTACT YOUR LOCAL CONTECH REP FOR MODIFICATIONS.

The design and information shown on this drawing is provided as a service to the project owner, engineer and contractor by Contech Engineered Solutions LLC ("Contech"). Neither this drawing, nor any part thereof, may be used, reproduced or modified in any manner without the prior written consent of Contech. Failure to comply is done at the user's own risk and Contech expressly disclaims any liability or responsibility for such use.

If discrepancies between the supplied information upon which the drawing is based and actual field conditions are encountered as site work progresses, these discrepancies must be reported to Contech immediately for re-evaluation of the design. Contech accepts no liability for designs based on missing, incomplete or inaccurate information supplied by others.

DATE	REVISION DESCRIPTION	BY

CONTECH
ENGINEERED SOLUTIONS LLC
www.ContechES.com
9025 Centre Pointe Dr., Suite 400, West Chester, OH 45069
800-338-1122 513-645-7000 513-645-7993 FAX

CONTECH
CMP DETENTION SYSTEMS
CONTECH
DYODS
DRAWING

DY010714 Warmington
Retention System-Medical Center Dr
Fontana, CA
DETENTION SYSTEM

PROJECT No.: 6662	SEQ. No.: 10714	DATE: 9/30/2021
DESIGNED: DYO	DRAWN: DYO	
CHECKED: DYO	APPROVED: DYO	
SHEET NO.:		D3

CMP DETENTION INSTALLATION GUIDE

PROPER INSTALLATION OF A FLEXIBLE UNDERGROUND DETENTION SYSTEM WILL ENSURE LONG-TERM PERFORMANCE. THE CONFIGURATION OF THESE SYSTEMS OFTEN REQUIRES SPECIAL CONSTRUCTION PRACTICES THAT DIFFER FROM CONVENTIONAL FLEXIBLE PIPE CONSTRUCTION. CONTECH ENGINEERED SOLUTIONS STRONGLY SUGGESTS SCHEDULING A PRE-CONSTRUCTION MEETING WITH YOUR LOCAL SALES ENGINEER TO DETERMINE IF ADDITIONAL MEASURES, NOT COVERED IN THIS GUIDE, ARE APPROPRIATE FOR YOUR SITE.

FOUNDATION

CONSTRUCT A FOUNDATION THAT CAN SUPPORT THE DESIGN LOADING APPLIED BY THE PIPE AND ADJACENT BACKFILL WEIGHT AS WELL AS MAINTAIN ITS INTEGRITY DURING CONSTRUCTION.

IF SOFT OR UNSUITABLE SOILS ARE ENCOUNTERED, REMOVE THE POOR SOILS DOWN TO A SUITABLE DEPTH AND THEN BUILD UP TO THE APPROPRIATE ELEVATION WITH A COMPETENT BACKFILL MATERIAL. THE STRUCTURAL FILL MATERIAL GRADATION SHOULD NOT ALLOW THE MIGRATION OF FINES, WHICH CAN CAUSE SETTLEMENT OF THE DETENTION SYSTEM OR PAVEMENT ABOVE. IF THE STRUCTURAL FILL MATERIAL IS NOT COMPATIBLE WITH THE UNDERLYING SOILS AN ENGINEERING FABRIC SHOULD BE USED AS A SEPARATOR. IN SOME CASES, USING A STIFF REINFORCING GEOGRID REDUCES OVER EXCAVATION AND REPLACEMENT FILL QUANTITIES.

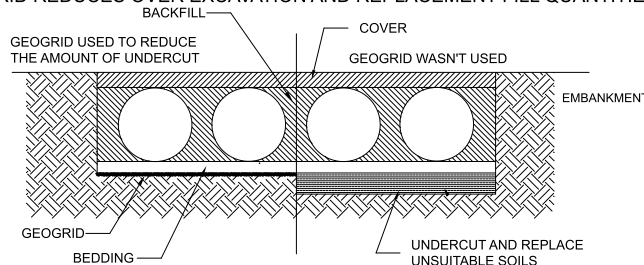

GRADE THE FOUNDATION SUBGRADE TO A UNIFORM OR SLIGHTLY SLOPING GRADE. IF THE SUBGRADE IS CLAY OR RELATIVELY NON-POROUS AND THE CONSTRUCTION SEQUENCE WILL LAST FOR AN EXTENDED PERIOD OF TIME, IT IS BEST TO SLOPE THE GRADE TO ONE END OF THE SYSTEM. THIS WILL ALLOW EXCESS WATER TO DRAIN QUICKLY, PREVENTING SATURATION OF THE SUBGRADE.

GEOMEMBRANE BARRIER

A SITE'S RESISTIVITY MAY CHANGE OVER TIME WHEN VARIOUS TYPES OF SALTING AGENTS ARE USED, SUCH AS ROAD SALTS FOR DEICING AGENTS. IF SALTING AGENTS ARE USED ON OR NEAR THE PROJECT SITE, A GEOMEMBRANE BARRIER IS RECOMMENDED WITH THE SYSTEM. THE GEOMEMBRANE LINER IS INTENDED TO HELP PROTECT THE SYSTEM FROM THE POTENTIAL ADVERSE EFFECTS THAT MAY RESULT FROM THE USE OF SUCH AGENTS INCLUDING PREMATURE CORROSION AND REDUCED ACTUAL SERVICE LIFE.

THE PROJECT'S ENGINEER OF RECORD IS TO EVALUATE WHETHER SALTING AGENTS WILL BE USED ON OR NEAR THE PROJECT SITE, AND USE HIS/HER BEST JUDGEMENT TO DETERMINE IF ANY ADDITIONAL PROTECTIVE MEASURES ARE REQUIRED. BELOW IS A TYPICAL DETAIL SHOWING THE PLACEMENT OF A GEOMEMBRANE BARRIER FOR PROJECTS WHERE SALTING AGENTS ARE USED ON OR NEAR THE PROJECT SITE.

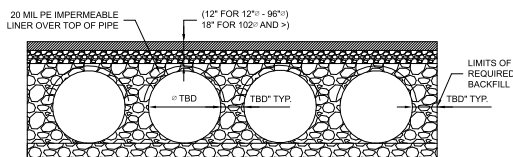

IN-SITU TRENCH WALL

IF EXCAVATION IS REQUIRED, THE TRENCH WALL NEEDS TO BE CAPABLE OF SUPPORTING THE LOAD THAT THE PIPE SHEDS AS THE SYSTEM IS LOADED. IF SOILS ARE NOT CAPABLE OF SUPPORTING THESE LOADS, THE PIPE CAN DEFLECT. PERFORM A SIMPLE SOIL PRESSURE CHECK USING THE APPLIED LOADS TO DETERMINE THE LIMITS OF EXCAVATION BEYOND THE SPRING LINE OF THE OUTER MOST PIPES.

IN MOST CASES THE REQUIREMENTS FOR A SAFE WORK ENVIRONMENT AND PROPER BACKFILL PLACEMENT AND COMPACTION TAKE CARE OF THIS CONCERN.

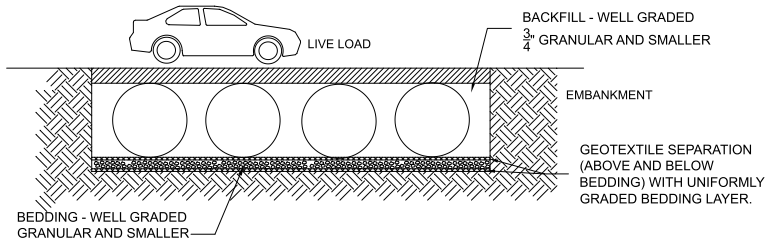

BACKFILL PLACEMENT

MATERIAL SHALL BE WORKED INTO THE PIPE HAUNCHES BY MEANS OF SHOVEL-SLICING, RODDING, AIR TAMPER, VIBRATORY ROD, OR OTHER EFFECTIVE METHODS.

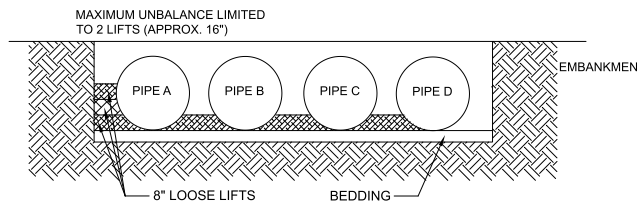

IF AASHTO T99 PROCEDURES ARE DETERMINED INFEASIBLE BY THE GEOTECHNICAL ENGINEER OF RECORD, COMPACTION IS CONSIDERED ADEQUATE WHEN NO FURTHER YIELDING OF THE MATERIAL IS OBSERVED UNDER THE COMPACTOR, OR UNDER FOOT, AND THE GEOTECHNICAL ENGINEER OF RECORD (OR REPRESENTATIVE THEREOF) IS SATISFIED WITH THE LEVEL OF COMPACTION.

FOR LARGE SYSTEMS, CONVEYOR SYSTEMS, BACKHOES WITH LONG REACHES OR DRAGLINES WITH STONE BUCKETS MAY BE USED TO PLACE BACKFILL. ONCE MINIMUM COVER FOR CONSTRUCTION LOADING ACROSS THE ENTIRE WIDTH OF THE SYSTEM IS REACHED, ADVANCE THE EQUIPMENT TO THE END OF THE RECENTLY PLACED FILL, AND BEGIN THE SEQUENCE AGAIN UNTIL THE SYSTEM IS COMPLETELY BACKFILLED. THIS TYPE OF CONSTRUCTION SEQUENCE PROVIDES ROOM FOR STOCKPILED BACKFILL DIRECTLY BEHIND THE BACKHOE, AS WELL AS THE MOVEMENT OF CONSTRUCTION TRAFFIC. MATERIAL STOCKPILES ON TOP OF THE BACKFILLED DETENTION SYSTEM SHOULD BE LIMITED TO 8- TO 10- FEET HIGH AND MUST PROVIDE BALANCED LOADING ACROSS ALL BARRELS. TO DETERMINE THE PROPER COVER OVER THE PIPES TO ALLOW THE MOVEMENT OF CONSTRUCTION EQUIPMENT SEE TABLE 1, OR CONTACT YOUR LOCAL CONTECH SALES ENGINEER.

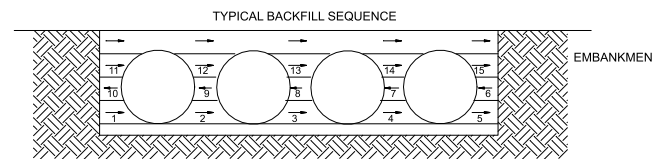

WHEN FLOWABLE FILL IS USED, YOU MUST PREVENT PIPE FLOATATION. TYPICALLY, SMALL LIFTS ARE PLACED BETWEEN THE PIPES AND THEN ALLOWED TO SET-UP PRIOR TO THE PLACEMENT OF THE NEXT LIFT. THE ALLOWABLE THICKNESS OF THE CLSM LIFT IS A FUNCTION OF A PROPER BALANCE BETWEEN THE UPLIFT FORCE OF THE CLSM, THE OPPOSING WEIGHT OF THE PIPE, AND THE EFFECT OF OTHER RESTRAINING MEASURES. THE PIPE CAN CARRY LIMITED FLUID PRESSURE WITHOUT PIPE DISTORTION OR DISPLACEMENT, WHICH ALSO AFFECTS THE CLSM LIFT THICKNESS. YOUR LOCAL CONTECH SALES ENGINEER CAN HELP DETERMINE THE PROPER LIFT THICKNESS.

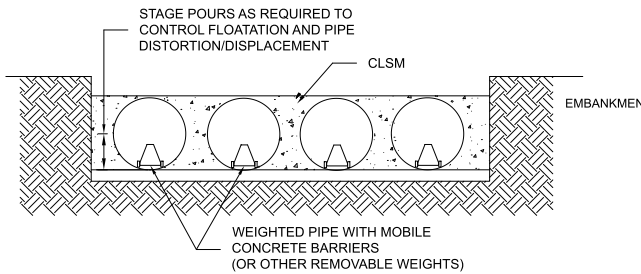

CONSTRUCTION LOADING

TYPICALLY, THE MINIMUM COVER SPECIFIED FOR A PROJECT ASSUMES H-20 LIVE LOAD. BECAUSE CONSTRUCTION LOADS OFTEN EXCEED DESIGN LIVE LOADS, INCREASED TEMPORARY MINIMUM COVER REQUIREMENTS ARE NECESSARY. SINCE CONSTRUCTION EQUIPMENT VARIES FROM JOB TO JOB, IT IS BEST TO ADDRESS EQUIPMENT SPECIFIC MINIMUM COVER REQUIREMENTS WITH YOUR LOCAL CONTECH SALES ENGINEER DURING YOUR PRE-CONSTRUCTION MEETING.

ADDITIONAL CONSIDERATIONS

BECAUSE MOST SYSTEMS ARE CONSTRUCTED BELOW-GRADE, RAINFALL CAN RAPIDLY FILL THE EXCAVATION; POTENTIALLY CAUSING FLOATATION AND MOVEMENT OF THE PREVIOUSLY PLACED PIPES. TO HELP MITIGATE POTENTIAL PROBLEMS, IT IS BEST TO START THE INSTALLATION AT THE DOWNSTREAM END WITH THE OUTLET ALREADY CONSTRUCTED TO ALLOW A ROUTE FOR THE WATER TO ESCAPE. TEMPORARY DIVERSION MEASURES MAY BE REQUIRED FOR HIGH FLOWS DUE TO THE RESTRICTED NATURE OF THE OUTLET PIPE.

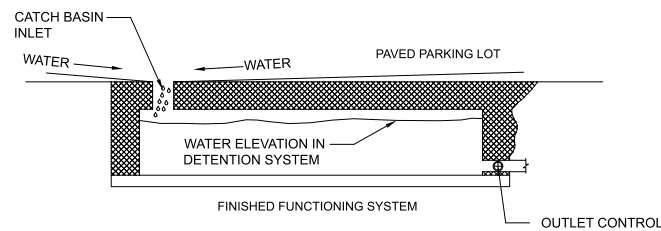

CMP DETENTION SYSTEM INSPECTION AND MAINTENANCE

UNDERGROUND STORMWATER DETENTION AND INFILTRATION SYSTEMS MUST BE INSPECTED AND MAINTAINED AT REGULAR INTERVALS FOR PURPOSES OF PERFORMANCE AND LONGEVITY.

INSPECTION

INSPECTION IS THE KEY TO EFFECTIVE MAINTENANCE OF CMP DETENTION SYSTEMS AND IS EASILY PERFORMED. CONTECH RECOMMENDS ONGOING, ANNUAL INSPECTIONS. SITES WITH HIGH TRASH LOAD OR SMALL OUTLET CONTROL ORIFICES MAY NEED MORE FREQUENT INSPECTIONS. THE RATE AT WHICH THE SYSTEM COLLECTS POLLUTANTS WILL DEPEND MORE ON SITE SPECIFIC ACTIVITIES RATHER THAN THE SIZE OR CONFIGURATION OF THE SYSTEM.

INSPECTIONS SHOULD BE PERFORMED MORE OFTEN IN EQUIPMENT WASHDOWN AREAS, IN CLIMATES WHERE SANDING AND/OR SALTING OPERATIONS TAKE PLACE, AND IN OTHER VARIOUS INSTANCES IN WHICH ONE WOULD EXPECT HIGHER ACCUMULATIONS OF SEDIMENT OR ABRASIVE/ CORROSIVE CONDITIONS. A RECORD OF EACH INSPECTION IS TO BE MAINTAINED FOR THE LIFE OF THE SYSTEM

MAINTENANCE

CMP DETENTION SYSTEMS SHOULD BE CLEANED WHEN AN INSPECTION REVEALS ACCUMULATED SEDIMENT OR TRASH IS CLOGGING THE DISCHARGE ORIFICE.

ACCUMULATED SEDIMENT AND TRASH CAN TYPICALLY BE EVACUATED THROUGH THE MANHOLE OVER THE OUTLET ORIFICE. IF MAINTENANCE IS NOT PERFORMED AS RECOMMENDED, SEDIMENT AND TRASH MAY ACCUMULATE IN FRONT OF THE OUTLET ORIFICE. MANHOLE COVERS SHOULD BE SECURELY SEATED FOLLOWING CLEANING ACTIVITIES. CONTECH SUGGESTS THAT ALL SYSTEMS BE DESIGNED WITH AN ACCESS/INSPECTION MANHOLE SITUATED AT OR NEAR THE INLET AND THE OUTLET ORIFICE. SHOULD IT BE NECESSARY TO GET INSIDE THE SYSTEM TO PERFORM MAINTENANCE ACTIVITIES, ALL APPROPRIATE PRECAUTIONS REGARDING CONFINED SPACE ENTRY AND OSHA REGULATIONS SHOULD BE FOLLOWED.

ANNUAL INSPECTIONS ARE BEST PRACTICE FOR ALL UNDERGROUND SYSTEMS. DURING THIS INSPECTION, IF EVIDENCE OF SALTING/DE-ICING AGENTS IS OBSERVED WITHIN THE SYSTEM, IT IS BEST PRACTICE FOR THE SYSTEM TO BE RINSED, INCLUDING ABOVE THE SPRING LINE SOON AFTER THE SPRING THAW AS PART OF THE MAINTENANCE PROGRAM FOR THE SYSTEM.

MAINTAINING AN UNDERGROUND DETENTION OR INFILTRATION SYSTEM IS EASIEST WHEN THERE IS NO FLOW ENTERING THE SYSTEM. FOR THIS REASON, IT IS A GOOD IDEA TO SCHEDULE THE CLEANOUT DURING DRY WEATHER.

THE FOREGOING INSPECTION AND MAINTENANCE EFFORTS HELP ENSURE UNDERGROUND PIPE SYSTEMS USED FOR STORMWATER STORAGE CONTINUE TO FUNCTION AS INTENDED BY IDENTIFYING RECOMMENDED REGULAR INSPECTION AND MAINTENANCE PRACTICES. INSPECTION AND MAINTENANCE RELATED TO THE STRUCTURAL INTEGRITY OF THE PIPE OR THE SOUNDNESS OF PIPE JOINT CONNECTIONS IS BEYOND THE SCOPE OF THIS GUIDE.

C:\EXPORT\TEMPLATES\CMP_V5.DWG 10/18/2019 10:02 AM

The design and information shown on this drawing is provided as a service to the project owner, engineer and contractor by Contech Engineered Solutions LLC ("Contech"). Neither this drawing, nor any part thereof, may be used, reproduced or modified in any manner without the prior written consent of Contech. Failure to comply is done at the user's own risk and Contech expressly disclaims any liability or responsibility for such use.

If discrepancies between the supplied information upon which the drawing is based and actual field conditions are encountered as site work progresses, these discrepancies must be reported to Contech immediately for re-evaluation of the design. Contech accepts no liability for designs based on missing, incomplete or inaccurate information supplied by others.

DATE	REVISION DESCRIPTION	BY

CONTECH
ENGINEERED SOLUTIONS LLC
www.ContechES.com
9025 Centre Pointe Dr., Suite 400, West Chester, OH 45069
800-338-1122 513-645-7000 513-645-7993 FAX

CONTECH
CMP DETENTION SYSTEMS
CONTECH
DYODS
DRAWING

DYO10714 Warmington
Retention System-Medical Center Dr
Fontana, CA
DETENTION SYSTEM

PROJECT No.: 6662	SEQ. No.: 10714	DATE: 9/30/2021
DESIGNED: DYO	DRAWN: DYO	
CHECKED: DYO	APPROVED: DYO	
SHEET NO.:		D4

Infiltration Drawdown Time Calculation:

(Combi 7-Chambers)

Infiltration Surface Area Provided:	9,072 SF	Combined Footprint of Inf Surface Area
Infiltration Rate per Soil Report	8.49 in/hr	(7-Contech Chamber System)
	0.71 ft/hr	
Factor of Safety	3	
Design Infiltration Rate	0.236 ft/hr	
Volume needed to be Infiltrated	50218 cu.ft	
Infiltration Volume per hour	2139.48 cu.ft/hr	(9072 sft * 0.236 ft/hr)
Infiltration Draw Down Time	23.47 Hours	(50218 cu.ft / 2139.48 cu.ft/hr)
	23.5 < 48 hr draw down time.	OK

Worksheet H: Factor of Safety and Design Infiltration Rate and Worksheet

Factor Category		Factor Description	Assigned Weight (w)	Factor Value (v)	Product (p) $p = w \times v$
A	Suitability Assessment	Soil assessment methods	0.25	1	0.25
		Predominant soil texture	0.25	2	0.50
		Site soil variability	0.25	2	0.50
		Depth to groundwater / impervious layer	0.25	1	0.25
		Suitability Assessment Safety Factor, $S_A = \Sigma p$			
B	Design	Tributary area size	0.25	2	0.50
		Level of pretreatment/ expected sediment loads	0.25	2	0.50
		Redundancy	0.25	3	0.75
		Compaction during construction	0.25	1	0.25
		Design Safety Factor, $S_B = \Sigma p$			
Combined Safety Factor, $S_{TOT} = S_A \times S_B$				3.00	
Measured Infiltration Rate, inch/hr, K_M (corrected for test-specific bias)				8.49	
Design Infiltration Rate, in/hr, $K_{DESIGN} = S_{TOT} / K_M$				2.83	
Supporting Data					
Briefly describe infiltration test and provide reference to test forms: Lowest measured Inf. Rate : 8.49 in/hr from Geotechnical and Infiltration Evaluation Report, August 21, 2021.					

Note: The minimum combined adjustment factor shall not be less than 2.0 and the maximum combined adjustment factor shall not exceed 9.0.

logged the excavations and collected soil samples for use in subsequent laboratory testing. The logs of the exploratory borings are included in Appendix A.

Relatively undisturbed soil samples were recovered at various intervals in the geotechnical borings with a California sampler. The California sampler is a 3-inch outside diameter, 2.5-inch inside diameter, split barrel sampler lined with brass rings. The sampler was 18 inches long. The sampler conformed to the requirements of ASTM D 3550. A 140-pound automatic trip hammer was utilized, dropping 30 inches for each blow. The relatively undisturbed samples, together with bulk samples of representative soil types, were returned to the laboratory for testing and evaluation. The California sampler test data are presented on the boring logs in Appendix A.

Percolation Testing

In addition to the geotechnical exploratory borings, two percolation test borings (I-1 and I-2) were excavated in the area of the proposed storm water management basin to depths of about 5 feet. Infiltration/percolation testing was conducted in these borings in general accordance with the requirements of the County of San Bernardino.

The percolation tests consisted of drilling an eight-inch diameter test hole to the desired depth and installing approximately two inches of gravel in the bottom of the hole. A three-inch diameter perforated PVC pipe, wrapped in a filter sock, was placed in the excavations and the annular space was filled with gravel to prevent caving within the boring. Water was then placed in the borings to presoak the holes and percolation testing was performed the following the pre-soak period. Following presoaking it was determined that "sandy soil" criteria was met within both percolation borings. The percolation tests were then performed which consisted of adding water to each test hole and measuring the water drop over a 10-minute period. The water drop was recorded for eight test intervals. Water was added to the test holes after each test interval. The field percolation rates were then converted to an infiltration rate using the Porchet Method.

The results of the conversions indicate infiltration rate range from about 8.49 to 8.74 inches per hour. Copies of the percolation data sheets and the Porchet infiltration rate conversion calculations are presented in Appendix C. No factors of safety were applied to the rates provided. Over the lifetime of the infiltration areas, the infiltration rates may be affected by sediment build up and biological activities, as well as local variations in near surface soil conditions. A suitable factor of safety should be applied to the field rate in designing the infiltration system.

DRAINAGE EXHIBIT

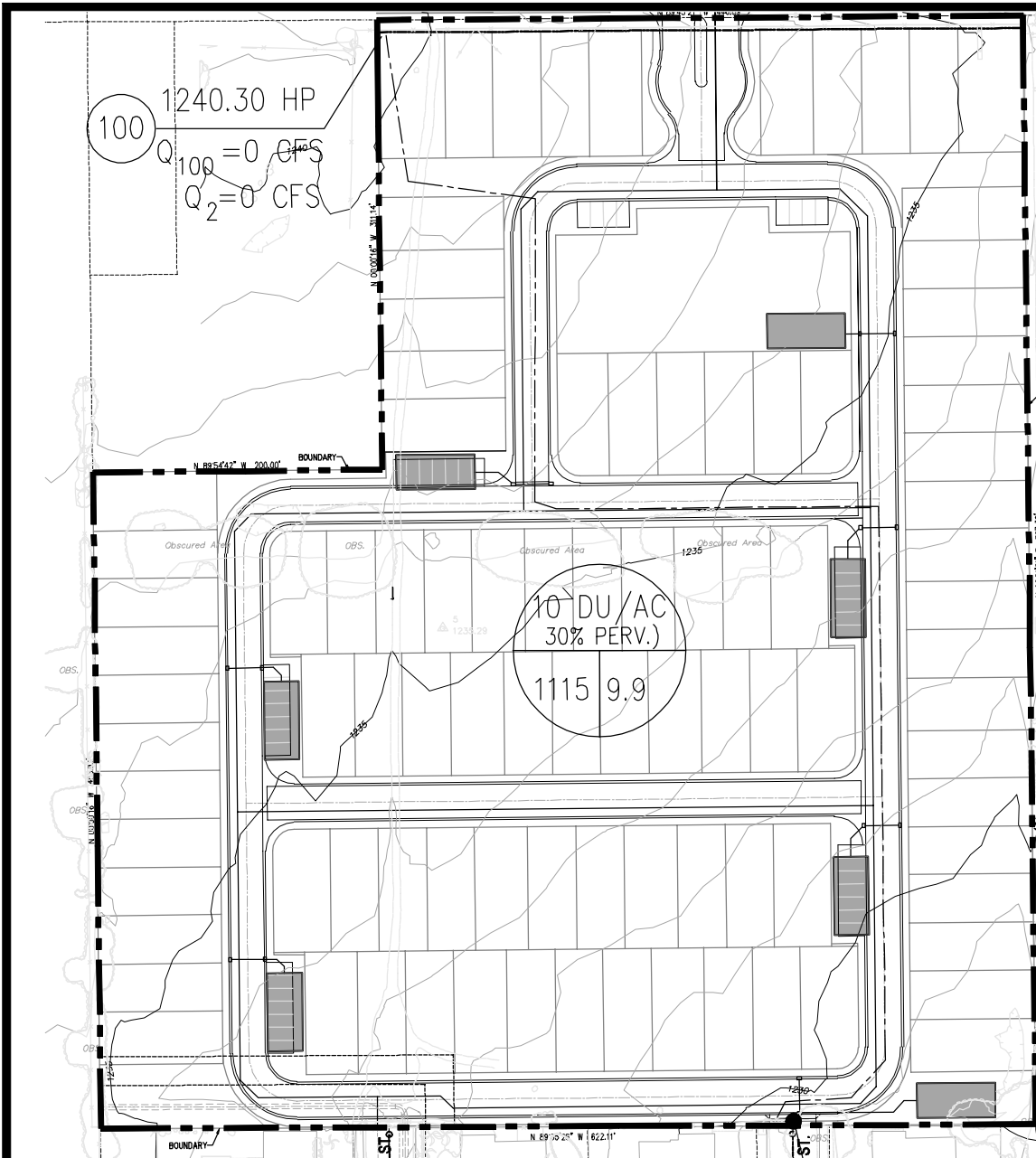

PROPOSED IMPERVIOUS COVER: 70%

LEGEND

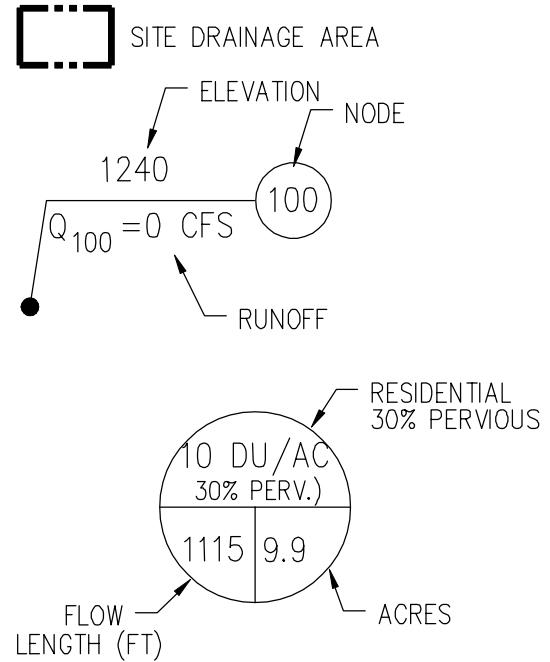

Prepared By:
ALLARD ENGINEERING
 Civil Engineering - Land Surveying - Land Planning
 16866 Seville Avenue
 Fontana, California 92335
 (909) 356-1815 Fax (909) 356-1795

SCALE: 1" = 120'

1228.16 FL
 Q₁₀₀ = 34.3 CFS
 Q₂ = 10.8 CFS
 101

APN: 0143-191-59
COUNTY OF SAN BERNARDINO
DRAINAGE EXHIBIT-DEVELOPED

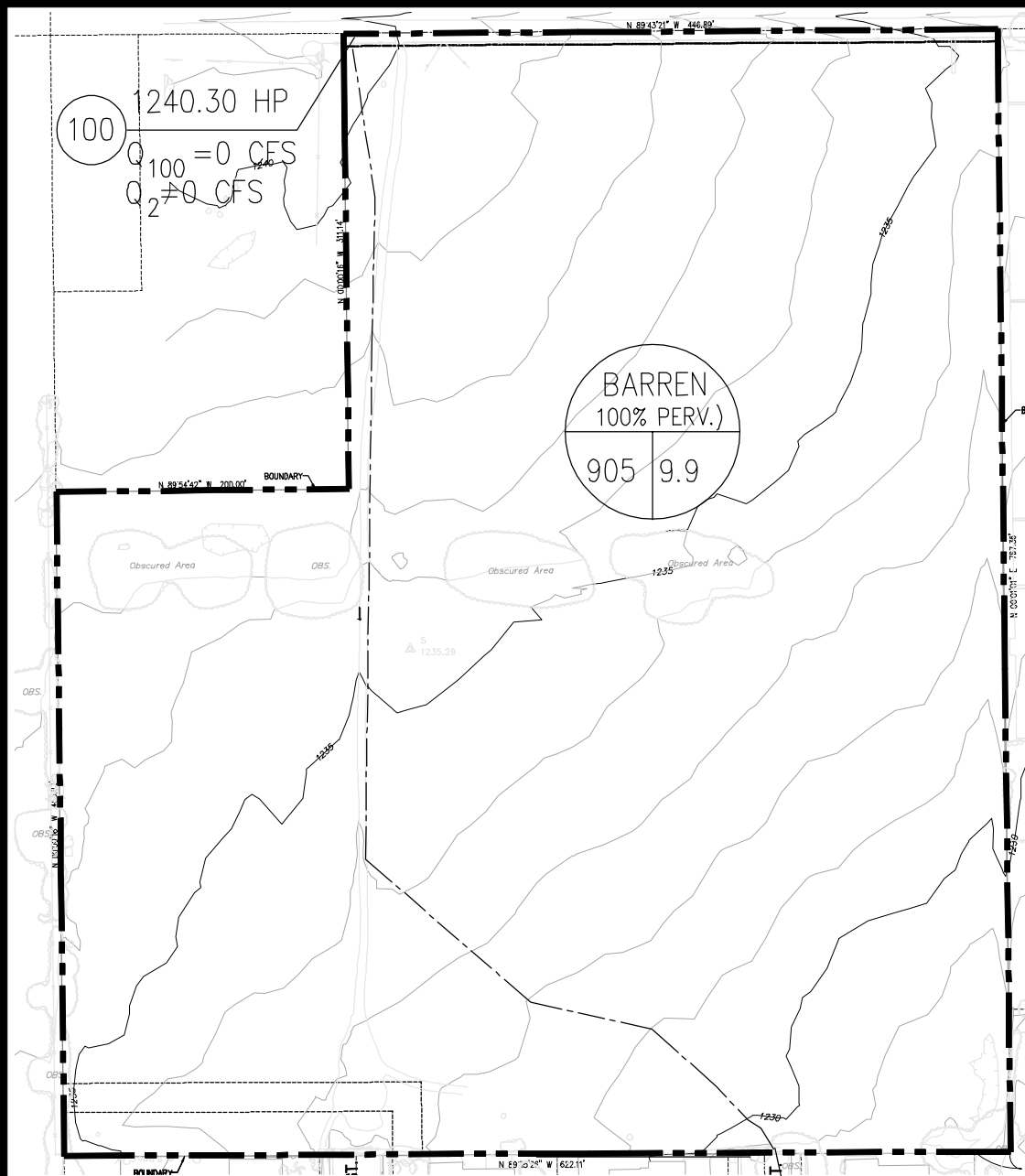

100
 1240.30 HP
 $Q_{100} = 0$ CFS
 $Q_2 \neq 0$ CFS

BARREN
 100% PERV.)
 905 | 9.9

1228.00 FL
 $Q_{100} = 21.0$ CFS
 $Q_2 = 2.3$ CFS
 101

PROPOSED IMPERVIOUS COVER: 0%

LEGEND

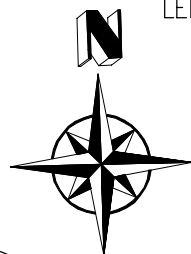
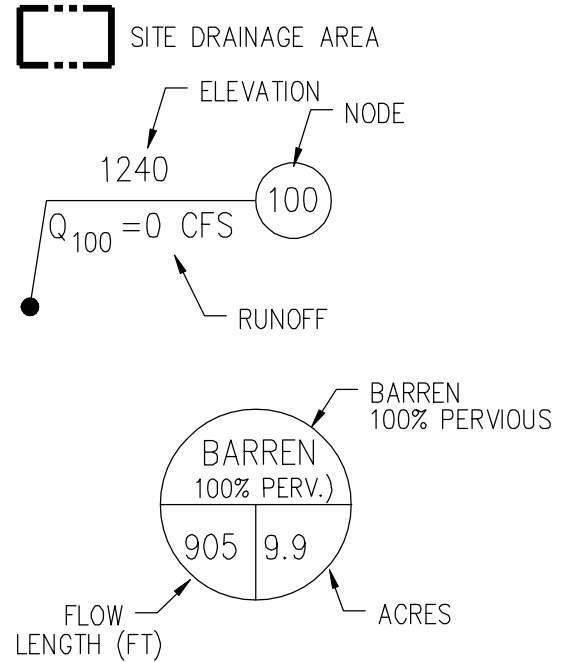

Prepared By:
ALLARD ENGINEERING
 Civil Engineering - Land Surveying - Land Planning
 16866 Seville Avenue
 Fontana, California 92335
 (909) 356-1815 Fax (909) 356-1795

SCALE: 1" = 120'

APN: 0143-191-59
COUNTY OF SAN BERNARDINO
DRAINAGE EXHIBIT-EXISTING

**OFFSITE DRAINAGE
EXHIBIT**



Prop. Site Area: 9.9 ac
(Density: 10 DU/AC, 3.5 cfs/ac)
Q100: 34.3 cfs

Area: 9.9 ac

Q100: 34.3 cfs

Q100 in Madison Street
~37.5 cfs
Street Capacity: 47.6 cfs

Q100: 3.2 cfs
Area: 1.5 ac

Off Site Area~ 10 ac
(Ex Density~6 DU/AC, 2.1 cfs/ac)
Q100: 21.0 cfs

Area: 1.5 ac

Area: 10 ac

Q100 in 20th Street
~55.3 cfs
Street Capacity: 70.8 cfs



STREET CAPACITY CALCULATION

HYDRAULIC ELEMENTS - I PROGRAM PACKAGE
(C) Copyright 1982-2016 Advanced Engineering Software (aes)
Ver. 23.0 Release Date: 07/01/2016 License ID 1400

Analysis prepared by:

TIME/DATE OF STUDY: 13:00 10/06/2021
=====

Problem Descriptions:
Madison Street Capacity ROW to ROW (50' Wide)
100-year Storm event

>>>STREETFLOW MODEL INPUT INFORMATION<<<<

CONSTANT STREET GRADE(FEET/FEET) = 0.010000
CONSTANT STREET FLOW DEPTH(FEET) = 0.60
AVERAGE STREETFLOW FRICTION FACTOR(MANNING) = 0.015000
CONSTANT SYMMETRICAL STREET HALF-WIDTH(FEET) = 18.00
DISTANCE FROM CROWN TO CROSSFALL GRADEBREAK(FEET) = 7.00
INTERIOR STREET CROSSFALL(DECIMAL) = 0.020000
OUTSIDE STREET CROSSFALL(DECIMAL) = 0.020000
CONSTANT SYMMETRICAL CURB HEIGHT(FEET) = 0.50
CONSTANT SYMMETRICAL GUTTER-WIDTH(FEET) = 1.50
CONSTANT SYMMETRICAL GUTTER-LIP(FEET) = 0.03125
CONSTANT SYMMETRICAL GUTTER-HIKE(FEET) = 0.12500
FLOW ASSUMED TO FILL STREET EVENLY ON BOTH SIDES
=====

STREET FLOW MODEL RESULTS:

NOTE: STREET FLOW EXCEEDS TOP OF CURB.
THE FOLLOWING STREET FLOW RESULTS ARE BASED ON THE ASSUMPTION
THAT NEGLIBLE FLOW OCCURS OUTSIDE OF THE STREET CHANNEL.
THAT IS, ALL FLOW ALONG THE PARKWAY, ETC., IS NEGLECTED.
STREET FLOW DEPTH(FEET) = 0.60
HALFSTREET FLOOD WIDTH(FEET) = 18.00
HALFSTREET FLOW(CFS) = 23.83
AVERAGE FLOW VELOCITY(FEET/SEC.) = 4.38
PRODUCT OF DEPTH&VELOCITY = 2.63
=====

Full Street Capacity: 47.6 cfs

HYDRAULIC ELEMENTS - I PROGRAM PACKAGE
(C) Copyright 1982-2016 Advanced Engineering Software (aes)
Ver. 23.0 Release Date: 07/01/2016 License ID 1400

Analysis prepared by:

TIME/DATE OF STUDY: 10:08 09/29/2021
=====

Problem Descriptions:
STREET CAPACITY 20TH ST (60' ROW)
100-YR STROM

>>>STREETFLOW MODEL INPUT INFORMATION<<<<

CONSTANT STREET GRADE(FEET/FEET) = 0.010000
CONSTANT STREET FLOW DEPTH(FEET) = 0.70
AVERAGE STREETFLOW FRICTION FACTOR(MANNING) = 0.015000
CONSTANT SYMMETRICAL STREET HALF-WIDTH(FEET) = 30.00
DISTANCE FROM CROWN TO CROSSFALL GRADEBREAK(FEET) = 20.00
INTERIOR STREET CROSSFALL(DECIMAL) = 0.020000
OUTSIDE STREET CROSSFALL(DECIMAL) = 0.020000
CONSTANT SYMMETRICAL CURB HEIGHT(FEET) = 0.50
CONSTANT SYMMETRICAL GUTTER-WIDTH(FEET) = 1.50
CONSTANT SYMMETRICAL GUTTER-LIP(FEET) = 0.03125
CONSTANT SYMMETRICAL GUTTER-HIKE(FEET) = 0.12500
FLOW ASSUMED TO FILL STREET EVENLY ON BOTH SIDES

=====

STREET FLOW MODEL RESULTS:

NOTE: STREET FLOW EXCEEDS TOP OF CURB.
THE FOLLOWING STREET FLOW RESULTS ARE BASED ON THE ASSUMPTION
THAT NEGLIBLE FLOW OCCURS OUTSIDE OF THE STREET CHANNEL.
THAT IS, ALL FLOW ALONG THE PARKWAY, ETC., IS NEGLECTED.
STREET FLOW DEPTH(FEET) = 0.70
HALFSTREET FLOOD WIDTH(FEET) = 28.69
HALFSTREET FLOW(CFS) = 35.43
AVERAGE FLOW VELOCITY(FEET/SEC.) = 4.24
PRODUCT OF DEPTH&VELOCITY = 2.97

Full Street Capacity: 70.8 cfs